

COMPACT RAIL



ROLLCO
SPECIALIZED
ON LINEAR MOTION

Every care has been taken to ensure the accuracy of the information contained in this catalogue, but no liability can be accepted for any errors or omissions. We reserve the right to make changes without prior notice.

Any reproduction, even partial, is allowed only by written permission by Rollco.



**CLIMATE
COMPENSATED
PAPER**



Index

PRODUCT OVERVIEW	4
Characteristics	4
Application areas	4
System components	5
Technical data	5
Axial deviations in parallelism	5
18 SERIES	6
Slider	6
Rail	8
28 SERIES	9
Slider	9
Rail	11
43 SERIES	12
Slider	12
Rail	14
63 SERIES	15
Slider	15
Rail	17
ACCESSORIES	18
Rollers.....	18
Wipers for CSW-slider	19
Fixing Screws	19
Alignment Fixture	19
Manual Clamp Elements	20
ORDER CODES	21
Rail	21
Mounted Rail and Slider	21
Slider N...series	22
Slider CSW...series	22
TECHNICAL INFORMATION	23
Configuration and Behavior of the Slider under Yawing Moment M_z	23
Linear Accuracy	24
K + U-system Tolerance Compensation	27
Static Load	28
Fixing Holes	29
Joined Rails	30
CALCULATION FORMULAS	31
Examples	31
Service life	33
INSTALLATION INSTRUCTIONS	34
Adjusting the Sliders	34
Installation of Joined Rails	36
Remarks	36
OPERATING CONDITIONS	37
Corrosion Protection	37
Speed and Acceleration	37
Operating Temperatures	37
Preload	37
MAINTENANCE	38
Roller Lubrication	38
Lubrication of the Raceways	38
N-slider Lubrication	38
CSW-slider Lubrication	38

Product Overview

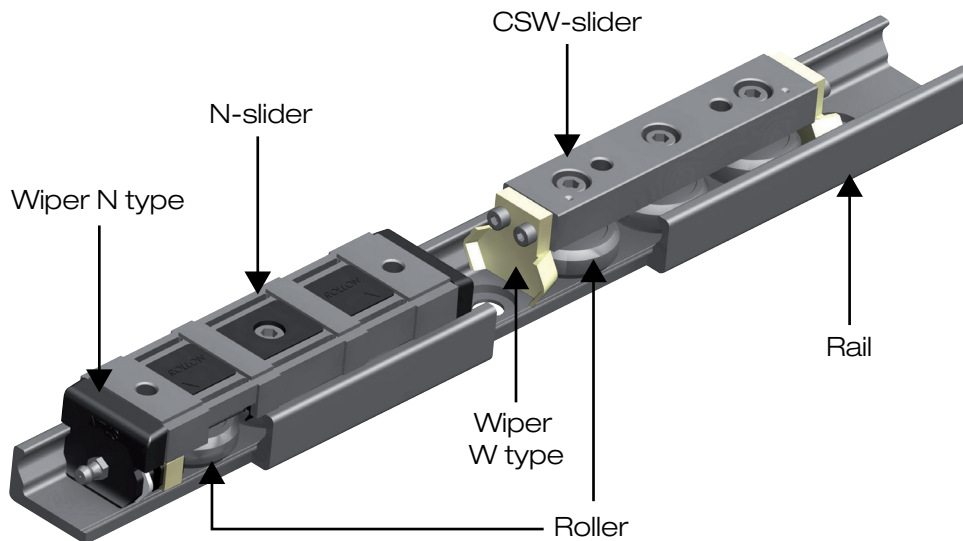

Compact rail is a product family of guide rails consisting of roller sliders with radial bearings which roll on the internal induction hardened and ground raceways of a C-profile made from cold-drawn roller bearing carbon steel.

Compact Rail consists of three product series; the fixed bearing rail, the compensating bearing rail and the floating rail. All products are available in zinc plating. Nickel plating is also available as an option. There are four different sizes of guide rails and many different version and lengths of the slide bearing.

Characteristics

- Compact size.
- Corrosion resistant surface.
- Not sensitive to dirt due to internal tracks.
- Hardened and ground raceways.
- Custom design TR-rail, also ground on the back of the rail and one side surface on request.
- Self-aligning in two planes.
- Quieter than recirculating ball systems.
- High operation speeds.
- Wide temperature range.
- Easy adjustment of slider in the guide rail.
- Zinc plated surface, on request chemically nickel plated.

Application areas

- Cutting machines
- Medical technology
- Packaging machines
- Photographic lighting equipment
- Construction and machine technology (doors, protective covers)
- Robots and manipulators
- Automation
- Handling

System components

- T-Rails – Fixed bearing rails used as the main load bearing in radial and axial forces.
- U-Rails – Floating bearing rails used for load bearing of radial forces and, in combination with the fixed bearing rail or compensation rail, as a support bearing for occurring moments.
- K-Rails – Compensation bearing rails used for the load bearing of radial and axial forces. Tolerance compensation in two planes can be implemented in combination with the compensating rail.
- N-slider – Closed design, available for sizes 18, 28, 43 and 63. Spring preloaded wipers and a self-lubrication kit are integrated in the end caps (except for size 18). Configurable with three rollers as standard, in sizes 28 and 43. A longer carriage with up to five rollers is also available on request.
- CSW-slider – Available for all sizes. Depending on the load case, slider is configurable with up to six rollers. Wipers available as option.
- Rollers – Available individually in all sizes as eccentric or concentric rollers. Optionally available with splash-proof plastic seal or with steel cover disc.
- Wipers – Available for slider type CSW to keep the raceways free of contamination and ensure a longer service life.
- Alignment fixture – Used during installation of joined rails for precise alignment of the rail transition from one to another.
- Manual clamp elements

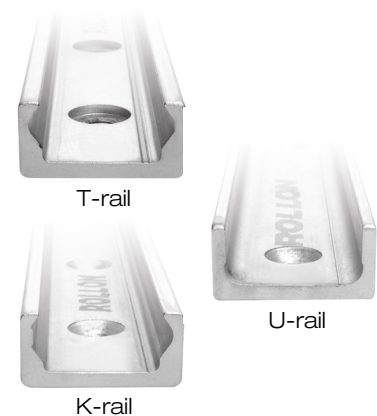

Technical data

- Available sizes for T-rail and U-rail: 18, 28, 43, 63. For K-rail: 43, 63.
- Max. operating speed: 9 m/s for size 63 (depending on application)
- Max. acceleration: 20 m/s² (depending on application)
- Max. radial load capacity: 15.000 N (per slider)
- Temperature range: -30°C to +120°C, briefly up to max. +170°C
- Rail material of T- and U-rails sizes 18 to 43: cold-drawn roller bearing steel C43 F. All K-rails, as well as T- and U-rails in size 63: CF53.
- Rail raceways induction hardened and ground
- Slider material of N-slider: Chemically nickel plated aluminium die cast body. CSW-slider: zinc-plated steel body.
- Rails and slider bodies are standard zinc-plated according to ISO 2081
- Roller material: steel 100Cr6
- Roller seal/shield: 2RS (splash-proof), 2Z (steel cover disk)
- Roller pins lubricated for life
- Wipers made of sturdy polyamide.

Axial deviations in parallelism

This problem occurs fundamentally by insufficient precision in the axial parallelism of the mounting surfaces, which results in an excessive load on the slider and thus causes drastically reduced service life. The use of fixed bearing and compensating bearing rail (T+U-system) solves the unique problem of aligning two track, parallel guide systems. By using a T+U-system, the T-rail takes over the motion of the track while the U-rail serves as a support bearing and takes only radial forces and M_z moments. A combination of compensation rail and floating bearing rail (K+U-system) also allows for deviations in parallelism and height offset.

Slider

N... series

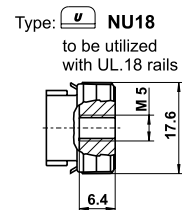
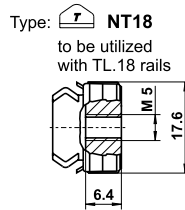
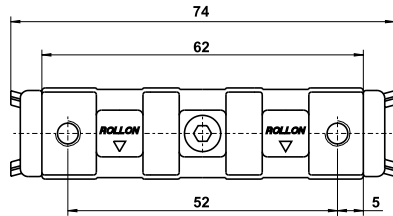

CSW... series

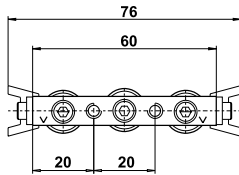

CSW18-60

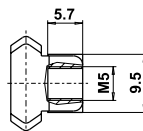

CSW18-T
To be utilized with TL.18 rails

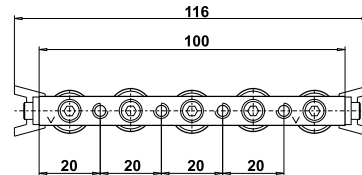

CSW18-100

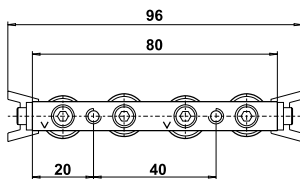

CSW18-80 configuration A

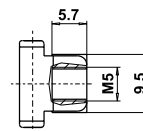

CSW18-U
To be utilized with UL.18 rails

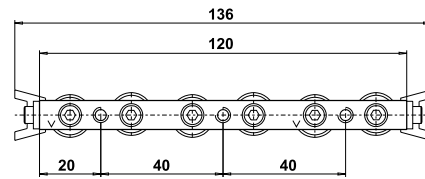

CSW18-120 configuration A

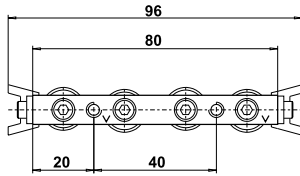

CSW18-80 configuration B

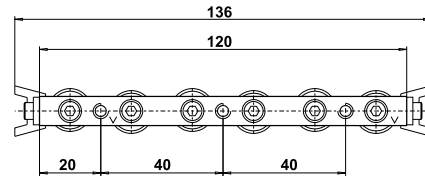

CSW18-120 configuration B

For more information regarding configurations, see Technical Information.

Article No.	No. of rollers	Type of roller*	No. of fixing holes	Weight (g)	Adjustment key
NT18 - NU18	3	CPA18 - CPN18	2	30	CK18
CSW18-60-2Z CSW 18-60-2RS	3	CPA18 - CPN18	2	40	CK18
CSW18-80-2Z CSW18-80-2RS	4	CPA18	2	50	CK18
CSW18-100-2Z CSW18-100-2RS	5	CPA18	4	60	CK18
CSW18-120-2Z CSW18-120-2RS	6	CPA18	3	70	CK18

*For roller characteristics see section for Rollers.

Load Capacity

The load capacities indicated in this paragraph refer to the “standard” positioning of the slider into the rail with the direction of the fixed rollers corresponding to that of the radial load.

Article No.	C	C _{0rad}	C _{0ax}	M _x	M _y	M _{zd}	M _z	M _{zs}
	N	N	N	Nm	Nm		Nm	
NT18	1530	820	260	1.5	4.7		8.2	
NU18	1530	820	0	0	0		8.2	
CSW18-60-..	1530	820	260	1.5	4.7		8.2	
CSW18-80-..-A	1530	820	300	2.8	7.0	8.2		24.7
CSW18-80-..-B	1530	820	300	2.8	7.0	24.7		8.2
CSW18-100-..	1830	975	360	2.8	9.4			24.7
CSW18-120-..-A	1830	975	440	3.3	11.8	24.7		41.1
CSW18-120-..-B	1830	975	440	3.3	11.8	41.1		24.7

Note: The load capacities indicated in the table refer to CSW sliders utilized with T.rails; the values of C_{0ax}, M_x and M_y are equal to 0 if used in U-rails.

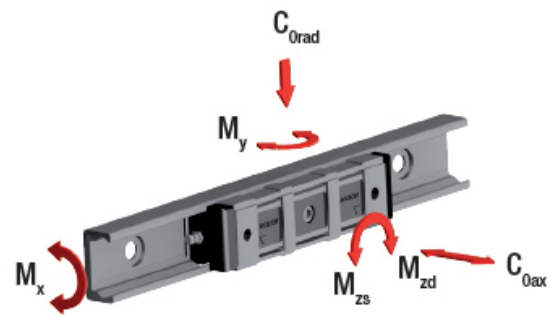

Rail

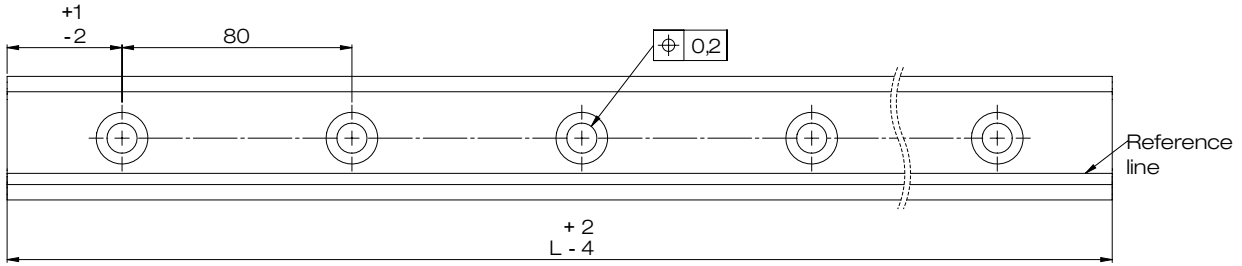

Rail weight: 550 g/m Max. length 2000 mm

With counterbored holes

Holes for M4 Torx® screws supplied together with the rails

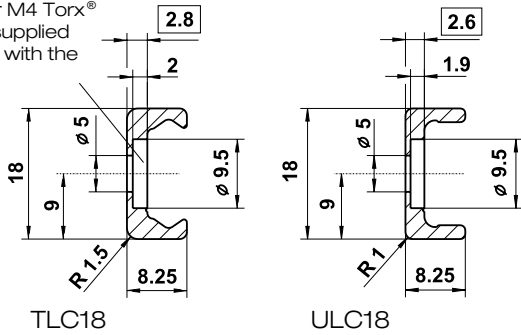

With countersunk holes

C'sunk holes for screws M4x0.7 DIN 7991

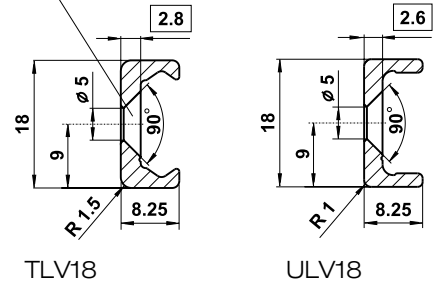

Mounted Rail/Slider

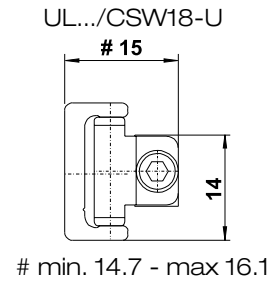
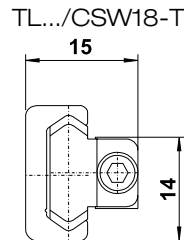
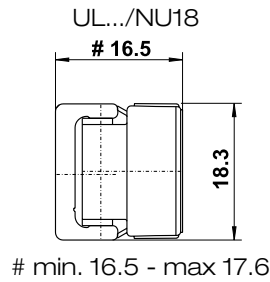
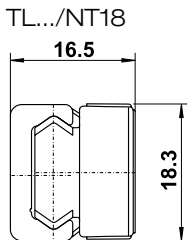

Slider

N... series

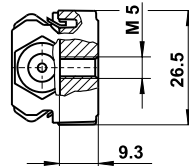
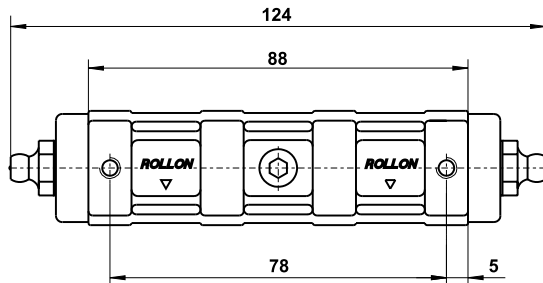

Type: **NT28**
To be utilized with TL.28 rails

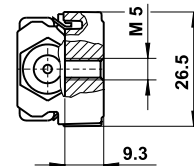

Type: **NU28**
To be utilized with UL.28 rails

CSW... series

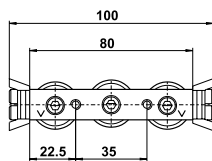

CSW28-80

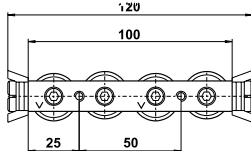

CSW28-100 configuration A

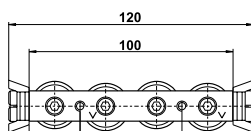

CSW28-100 configuration B

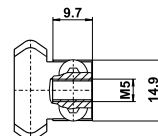

CSW28-T
To be utilized with TL.28 rails

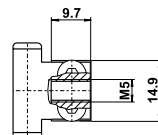

CSW28-U
To be utilized with UL.28 rails

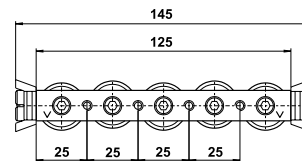

CSW28-125

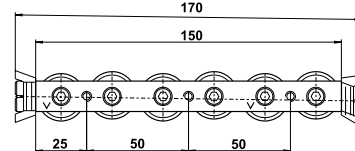

CSW28-150 configuration A

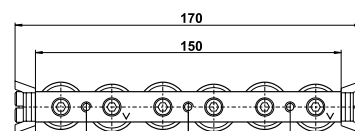

CSW28-150 configuration B

For more information regarding configurations, see Technical Information.

Slider type	No. of rollers	Type of roller*	No. of fixing holes	Weight (g)	Adjustment key
NTE28 - NUE28**	3	CPA28 - CPN28	2	115	CK28
CSW28-80-2Z CSW28-80-2RS	3	CPA28 - CPN28	2	155	CK28
CSW28-100-2Z CSW28-100-2RS	4	CPA28	2	195	CK28
CSW28-125-2Z CSW28-125-2RS	5	CPA28	4	240	CK28
CSW28-150-2Z CSW28-150-2RS	6	CPA28	3	290	CK28

*For roller characteristics section for Rollers.

**E = Lubrication pads

Load Capacity

The load capacities indicated in this paragraph refer to the “standard” positioning of the slider into the rail with the direction of the fixed rollers corresponding to that of the radial load.

Article No.	C	C _{0rad}	C _{0ax}	M _x	M _y	M _{zd}	M _{zs}
	N	N	N	Nm	Nm	Nm	Nm
NTE28	4260	2170	640	6.2	16.0	27.2	
NUE28	4260	2170	0	0	0	27.2	
CSW28-80-..	4260	2170	640	6.2	16.0	27.2	
CSW28-100-..-A	4260	2170	750	11.5	21.7	27.2	81.7
CSW28-100-..-B	4260	2170	750	11.5	21.7	81.7	27.2
CSW28-125	5065	2580	900	11.5	29.0	81.7	
CSW28-150-..-A	5065	2580	1070	13.7	36.2	81.7	136.1
CSW28-150-..-B	5065	2580	1070	13.7	36.2	136.1	81.7

Note: The load capacities indicated in the table refer to CSW sliders utilized with T.rails; the values of C_{0ax}, M_x and M_y are equal to 0 if used in U-rails.

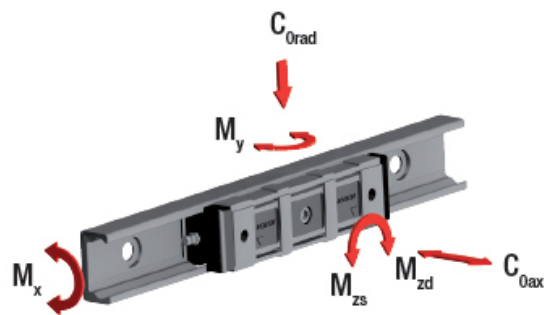

Rail

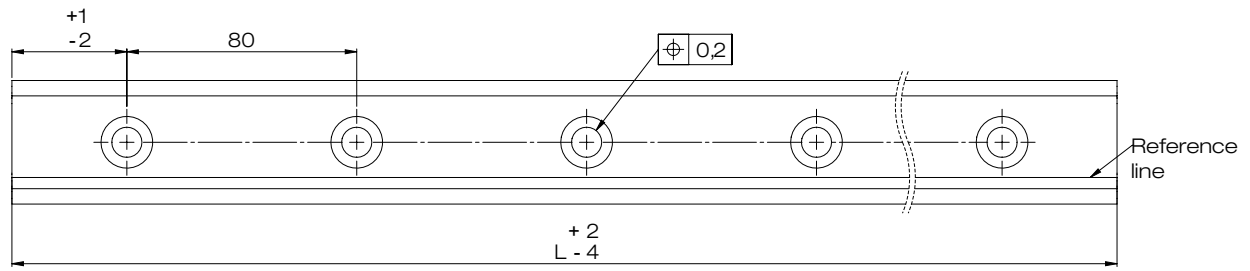

Rail weight: 1000 g/m Max length 3200 mm

With counterbored holes

Holes for M5 Torx® screws supplied together with the rails

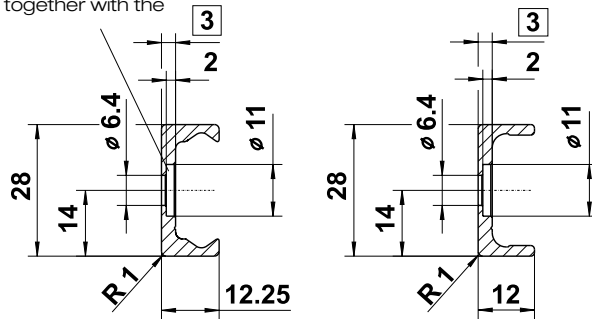

TLC28

ULC28

With countersunk holes

Countersunk holes for screws M5x0.8 DIN 7991

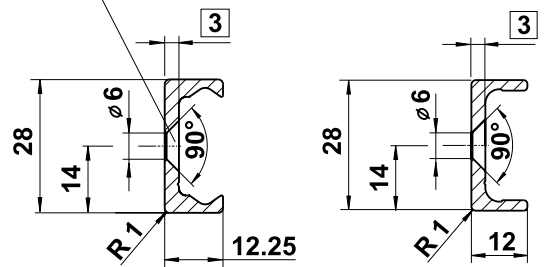

TLV28

ULV28

Mounted Rail/Slider

TL.../NT28

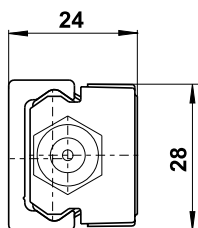

UL.../NU28

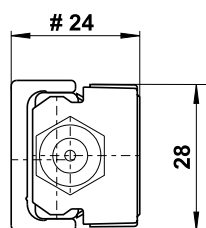

min. 24-max. 25.3

TL.../CSW28-T

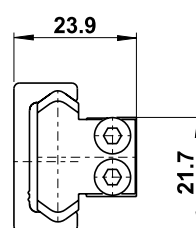

UL.../CSW28-U

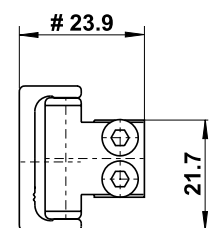

min. 23.3-max. 25.2

Slider

N... series

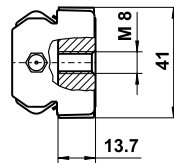
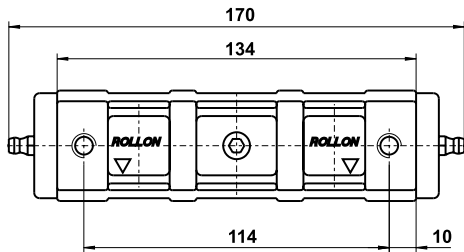

Type: **r** **NT43**
To be utilized with TL.43 rails

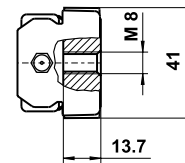

Type: **u** **NU43**
To be utilized with UL.43 rails

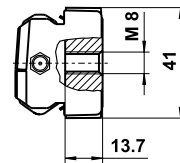

Type: **k** **NK43**
To be utilized with KL.43 rails

CSW... series

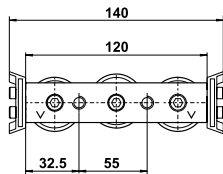

CSW43-120

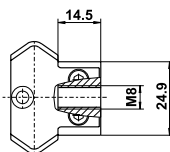

CSW43.-T
To be utilized with TL.43 rail

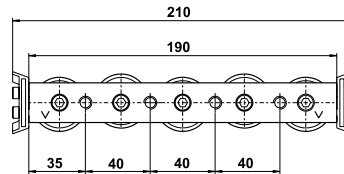

CSW43-190

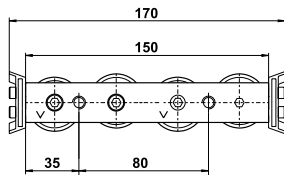

CSW43-150 configuration A

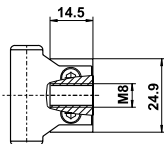

CSW43.-U
To be utilized with UL.43 rail

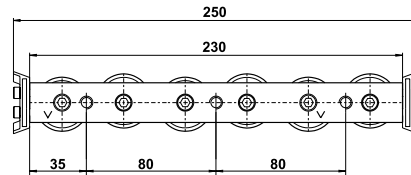

CSW43-230 configuration A

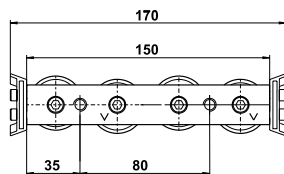

CSW43-150 configuration B

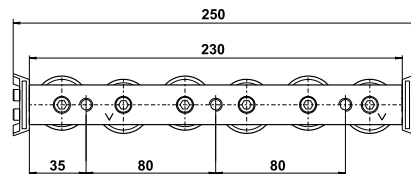

CSW43-230 configuration B

For more information regarding configurations, see Technical Information.

Slider type	No. of rollers	Type of roller*	No. of fixing holes	Weight (g)	Adjustment key
NTE43 - NUE43**	3	CPA43 - CPN43	2	385	CK43
NKE43**	3	CRA43 - CRN43	2	385	CK43
CSW43-120-2Z CSW43-120-2RS	3	CPA43 - CPN43	2	530	CK43
CSW43-150-2Z CSW43-100-2RS	4	CPA43	2	680	CK43
CSW43-190-2Z CSW43-125-2RS	5	CPA43	4	840	CK43
CSW43-230-2Z CSW43-230-2RS	6	CPA43	3	1010	CK43

*For roller characteristics see section for Rollers.

**E = Lubrication pads

Load Capacity

The load capacities indicated in this paragraph, refer to the “standard” positioning of the slider into the rail with the direction of the fixed rollers corresponding to that of the radial load.

Article No.	C	C _{0rad}	C _{0ax}	M _x	M _y	M _z	
	N	N	N	Nm	Nm	M _{zd}	M _{zs}
NTE43	12280	5500	1570	23.6	60.0	104.5	
NUE43	12280	5500	0	0	0	104.5	
NKE43	12280	5100	1320	0	50.4	96.9	
CSW43-120-..	12280	5500	1570	23.6	60.0	104.5	
CSW43-150-..-A	12280	5500	1855	43.6	81.5	104.5	313.5
CSW43-150-..-B	12280	5500	1855	43.6	81.5	313.5	104.5
CSW43-190-..	14675	6540	2215	43.6	108.6	313.5	
CSW43-230-..-A	14675	6540	2645	52.0	135.8	313.5	522.5
CSW43-230-..-B	14675	6540	2645	52.0	135.8	522.5	313.5

Note: The load capacities indicated in the table refer to CSW sliders utilized with T. rails; the values of C_{0ax}, M_x and M_y are equal to 0 if used in U-rails.

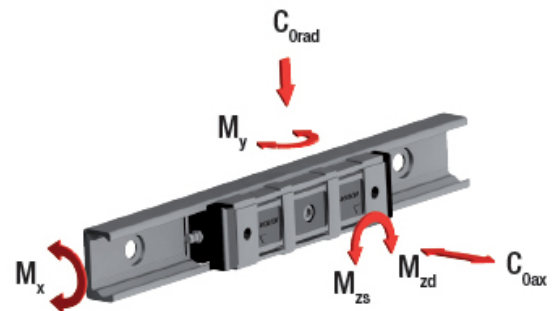

Rail

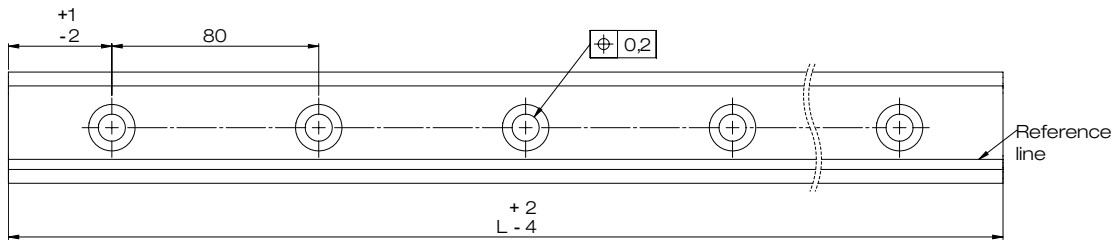

Rail weight: 2600 g/m Max length 4080 mm

With counterbored holes

Holes for M8 Torx® screws supplied together with the rails

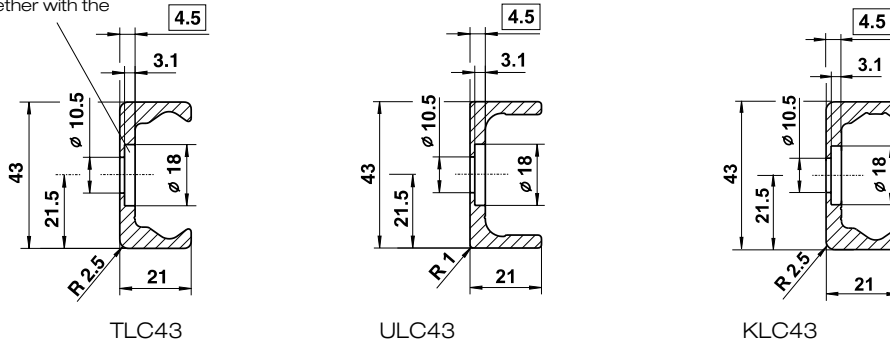

With countersunk holes

C'sunk holes for screws M8x1.25 DIN 7991

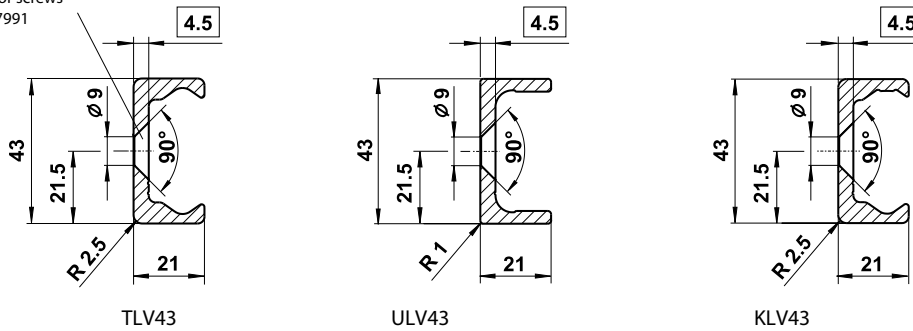

Mounted Rail/Slider

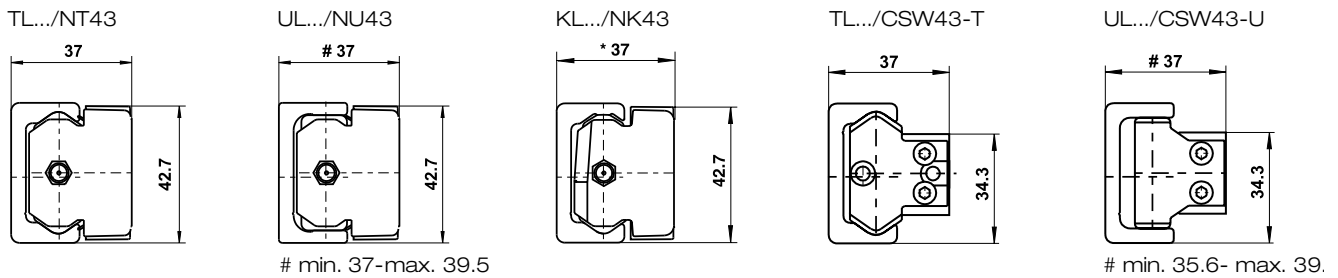

* The K-rail allows the K-slider to rotate, therefore this dimension will change under rotation. The K-rail must be mounted in such a way that the radial load is always carried by the rollers on the slider in contact with the "V" shaped raceway.

Slider

N... series

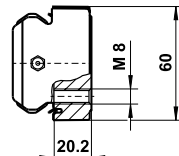
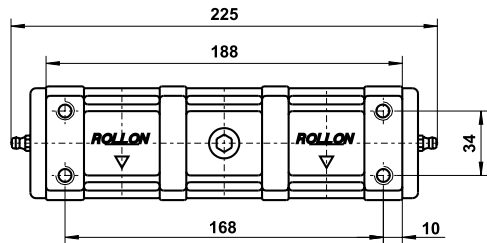

Type: **NT63**

To be utilized with TL.63 rails

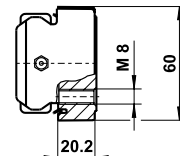

Type: **NU63**

To be utilized with UL.63 rails

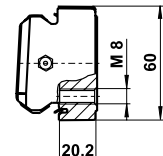

Type: **NK63**

To be utilized with KL.63 rails

CSW... series

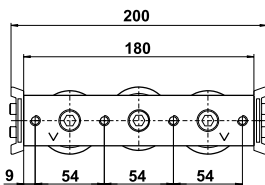

CSW63-180

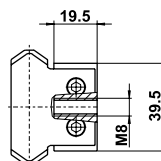

CSW63-T
To be utilized with TL.63 rails

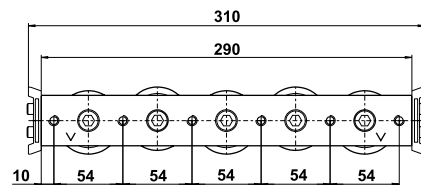

CSW63-290

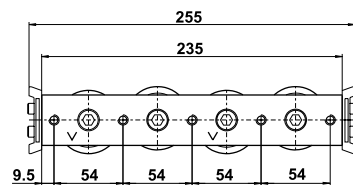

CSW63-235 configuration A

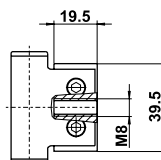

CSW63-U
To be utilized with UL.63 rails

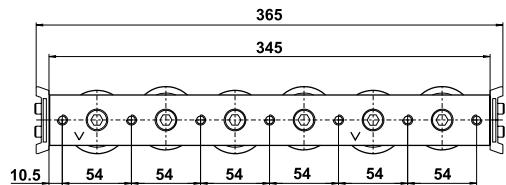

CSW63-345 configuration A

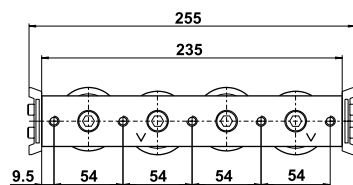

CSW63-235 configuration B

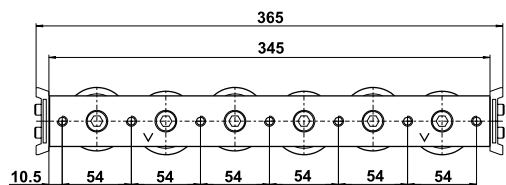

CSW63-345 configuration B

For more information regarding configurations, see Technical Information.

Slider type	No. of rollers	Type of roller*	No. of fixing holes	Weight (g)	Adjustment key
NTE63 - NUE63**	3	CPA43 - CPN63	4	1070	CK63
NKE63**	3	CRA63 - CRN63	4	1070	CK63
CSW63-180-2ZR	3	CPA63	4	1660	CK63
CSW63-235-2ZR	4	CPA63	5	2170	CK63
CSW63-290-2ZR	5	CPA63	6	2670	CK63
CSW63-345-2ZR	6	CPA63	7	3170	CK63

*For roller characteristics see section for Rollers.

**E = Lubrication pads

Load Capacity

The load capacities indicated in this paragraph, refer to the “standard” positioning of the slider into the rail with the direction of the fixed rollers corresponding to that of the radial load.

Article No.	C	C _{0rad}	C _{0ax}	M _x	M _y	M _z	
	N	N	N	Nm	Nm	M _{zd}	M _{zs}
NTE63	30750	12500	6000	125	271	367	
NUE63	30750	12500	0	0	0	367	
NKE63	30750	11550	5045	0	235	335	
CSW63-180-..	30750	12500	6000	125	271	367	
CSW63-235-..-A	30750	12500	7200	250	413	367	1100
CSW63-235-..-B	30750	12500	7200	250	413	1100	367
CSW63-290-..	36600	15000	8500	250	511	1100	
CSW63-345-..-A	36600	15000	10000	350	689	1100	1830
CSW63-345-..-B	36600	15000	10000	350	689	1830	1100

Note: The load capacities indicated in the table refer to CSW sliders utilized with T.. rails; the values of C_{0ax}, M_x and M_y are equal to 0 if used in U-rails.

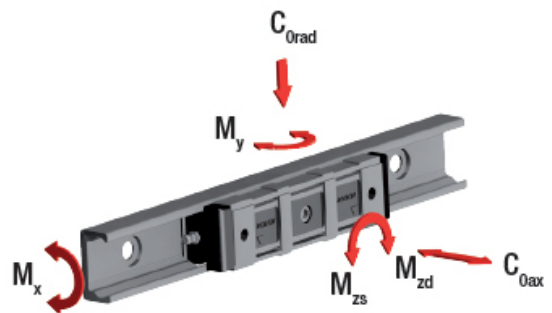

Rail

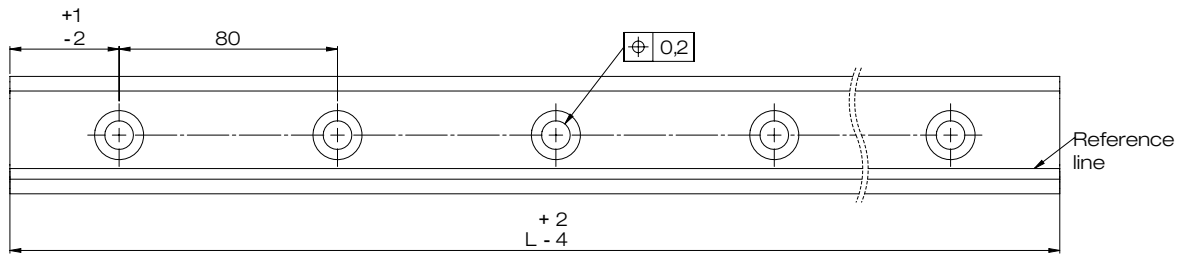

Rail weight: 6000 g/m Max. length 4080 mm

With counterbored holes

Holes for M8 "Torx" screws supplied together with the rails

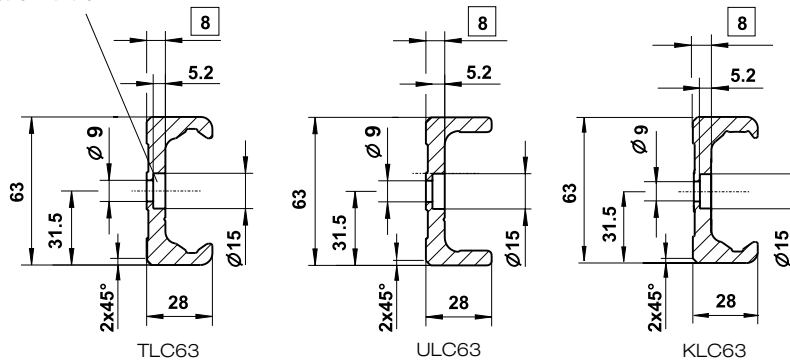

With countersunk holes

Countersunk holes for screws M10x1.5 DIN 7991

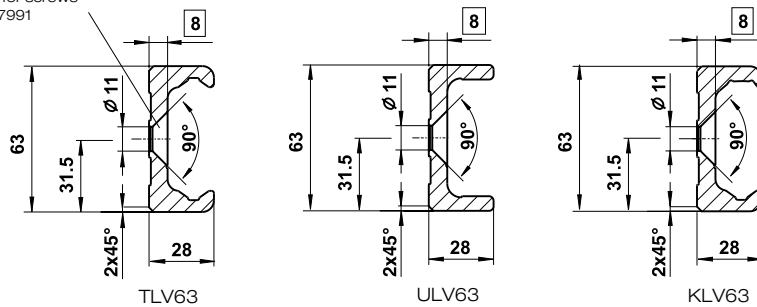

Mounted Rail/Slider

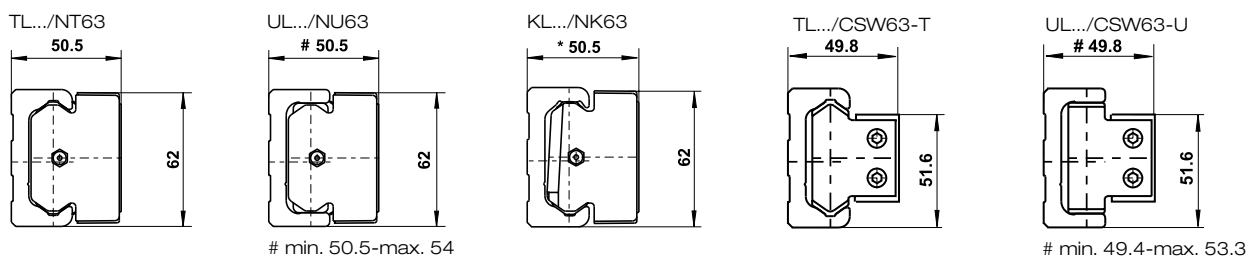

*The K-rail allows the K-slider to rotate, therefore this dimension will change under rotation. The K-rail must be mounted in such a way that the radial load is always carried by the rollers on the slider in contact with the "V" shaped raceway.

Rollers



Prismatic (T and U rail)

CPN

Concentric roller

CPA

Eccentric roller

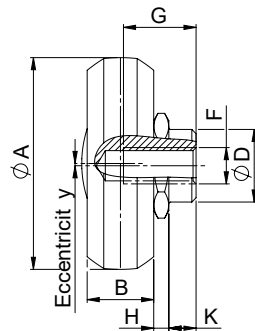

Crowned (K rail)

CRN

Concentric roller

CRA

Eccentric roller

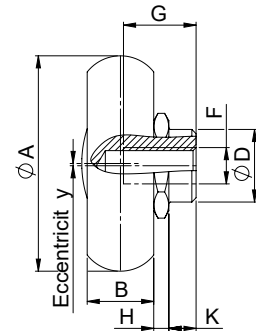

Article No.	Dimensions							F	C	C0rad	Weight
	A	B	D	e	H	K	G				
mm											
CPN18-2RS	14	4	6	-	1,55	1,8	5,5	M4	765	410	0,004
CPN18-2Z	14	4	6	-	1,55	1,8	5,5	M4	765	410	0,004
CPA18-2RS	14	4	6	0,4	1,55	1,8	5,5	M4	765	410	0,004
CPA18-2Z	14	4	6	0,4	1,55	1,8	5,5	M4	765	410	0,004
CPN28-2RS	23,2	7	10	-	2,2	3,8	7	M5	2130	1085	0,019
CPN28-2Z	23,2	7	10	-	2,2	3,8	7	M5	2130	1085	0,019
CPA28-2RS	23,2	7	10	0,6	2,2	3,8	7	M5	2130	1085	0,019
CPA28-2Z	23,2	7	10	0,6	2,2	3,8	7	M5	2130	1085	0,019
CPN43-2RS	35	11	12	-	2,5	4,5	12	M6	6140	2750	0,06
CPN43-2Z	35	11	12	-	2,5	4,5	12	M6	6140	2750	0,06
CPA43-2RS	35	11	12	0,8	2,5	4,5	12	M6	6140	2750	0,06
CPA43-2Z	35	11	12	0,8	2,5	4,5	12	M6	6140	2750	0,06
CPN63-2ZR	50	17,5	18	-	2,3	6	16	M8	15375	6250	0,19
CPA63-2ZR	50	17,5	18	1,2	2,3	6	16	M10	15375	6250	0,19
CRN43-2Z	35,6	11	12	-	2,5	4,5	12	M6	6140	2550	0,06
CRA43-2Z	35,6	11	12	0,8	2,5	4,5	12	M6	6140	2550	0,06
CRN63-2ZR	49,7	17,5	18	-	2,3	6	16	M8	15375	5775	0,19
CRA63-2ZR	49,7	17,5	18	1,2	2,3	6	16	M10	15375	5775	0,19

Wipers for CSW-slider



Wiper type WCST for T-rail

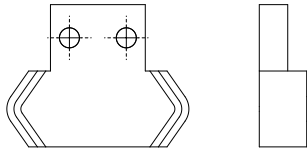

Wiper type WCSU for U-rail

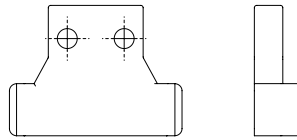

Wiper type WCSK for K-rail

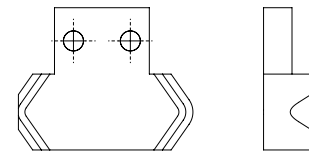

Fixing Screws

Rail size	d	D mm	L mm	K mm	S	Tightening torque Nm
18	M4x0,7	8	8	2	T20	3
28	M5x0,8	10	10	2	T25	9
43	M8x1,25	16	16	3	T40	22
63	M8x1,25	13	20	5	T40	35

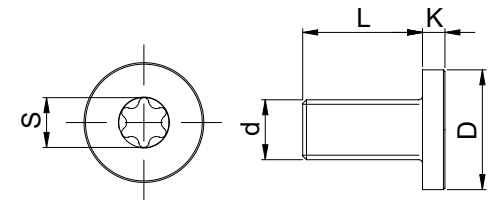

Rail size	Screw type	Usable thread length mm
18	M4x8	7,2
28	M5x10	9
43	M8x16	14,6
63	M8x20	17,2

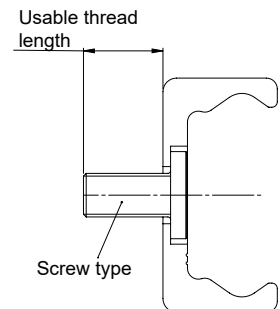

Alignment Fixture

Alignment fixture AT for joined rails

Rail size	Alignment fixture
18	AT 18
28	AT 28
43	AT 43
63	AT 63

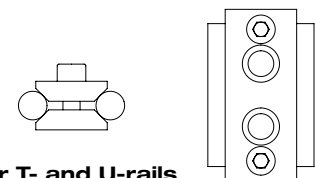

For T- and U-rails

Alignment fixture AK for joined rails

Rail size	Alignment fixture
43	AK 43
63	AK 63

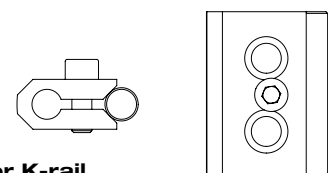

For K-rail

Manual Clamp Elements

Compact Rail guides can be secured with manual clamping elements. By using the freely adjustable clamping lever (except for HK 18, which uses hexagon socket bolt M6 DIN 913 with 3 mm drive) press the contact profile synchronously on the free surfaces of the rail. The floating mounted contact profiles guarantee symmetrical introduction of force on the guide rail.

The manual clamp elements are typically used for table cross beams and sliding beds, and during positioning optical equipment and measuring tables.

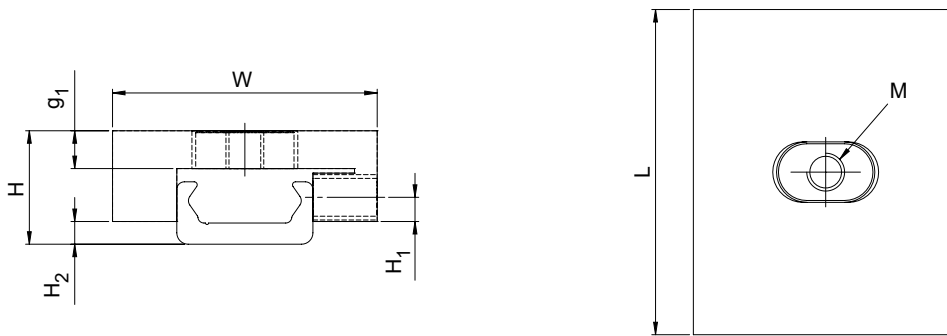

Clamp elements, HK18.

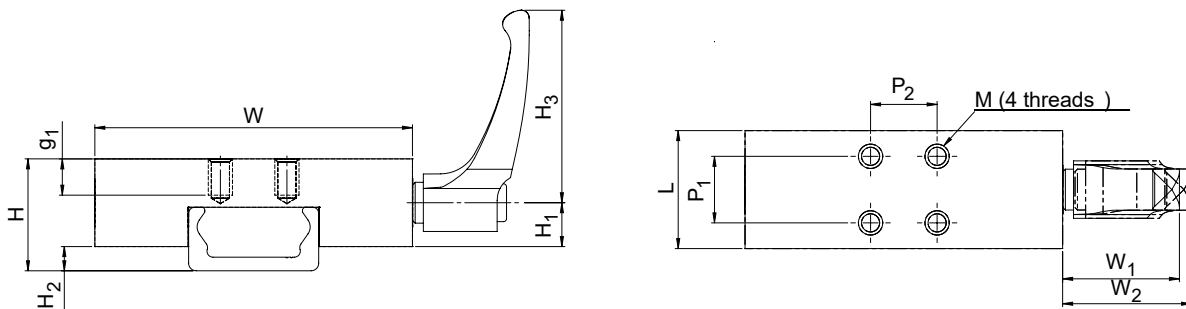

Clamp elements, HK28-63

Type	Size	Holding force N	Tightening torque Nm	Dimensions											
				H	H ₁	H ₂	H ₃	W	W ₁	W ₂	L	P ₁	P ₂	g1	M
HK1808A	18	150	0.5	15	3.2	3	-	35	-	-	43	0	0	6	M5
HK2808A	28	1200	7	24	17	5	64	68	38.5	41.5	24	15	15	6	M5
HK4308A	43	2000	15	37	28.5	8	78	105	46.5	50.5	39	22	22	12	M8
HK6308A	63	2000	15	50.5	35	9.5	80	138	54.5	59.5	44	26	26	12	M8

Rail

TLC43 - 3000 - 20 - 20 - NIC

Rail shape (T, U, or K)

(K is available for size 43 and 63)

Fixing holes (C or V)

Width of rail

Length of rail - maximum length in one piece (mm)

18: 2000, 28: 3200, 43: 4080, 63: 4080

Distance from end of rail to center of first hole

Distance from center of last hole to rail end

Surface treatment

Standard leave empty. NIC for nickle plated.

Note: For longer lengths, please contact Rollco

Mounted Rail and Slider

TLC43 - 2 - CSW43-150-2Z-A-T - 3000 - 20 - 20 - NIC

Rail type

No. of sliders on each rail

Slider type (CSW or N series)

Slider dimension

Slider body length

Roller protection shield type

Depending on slider type

Length of rail

Distance from end of rail to center of first hole

Distance from center of last hole to rail end

Surface treatment

Standard leave empty. NIC for nickle plated.

Note: For heavy preload please contact Rollco

Slider N...series

NTE 43

Slider type - available sizes:

18:	NT18	NU18	
28:	NTE28	NUE28	
43:	NTE43	NUE43	NKE43
63:	NTE63	NUE63	NKE63

Dimension (18, 28, 43, 63)

Slider CSW...series

CSW 43 - 150 - 2Z - A - T - NIC

Slider type

Dimension (18, 28, 43, 63)

Slider body length

Roller protection shield type (2Z, 2RS)

Configuration (A or B, only when necessary)

Type of wiper (T or U)

Surface treatment

Standard leave empty. NIC for nickle plated.

Technical Information

Configuration and Behavior of the Slider under Yawing Moment M_z

Individual slider under load moment M_z

When an overhanging load in an application with a single slider per rail cause an M_z moment in one direction, a 4 or 6 roller Compact Rail slider is available. These sliders are available in both configuration A and B in regards to the roller arrangement to counter the acting M_z moment. The moment capacity of these sliders in the M_z -direction varies significantly through spacing L_1 and L_2 in accordance with the direction of rotation of M_z . Especially in the use of two parallel rails, for example with a T+U-system, it is extremely important to pay attention to the correct combination of the slider configuration A and B, in order to use the maximum load capacities of the slider.

The diagrams below illustrate this concept of the A and B configuration for sliders with 4 and 6 rollers. The maximum allowable M_z -moment is identical in both directions for all 3 and 5 roller sliders.

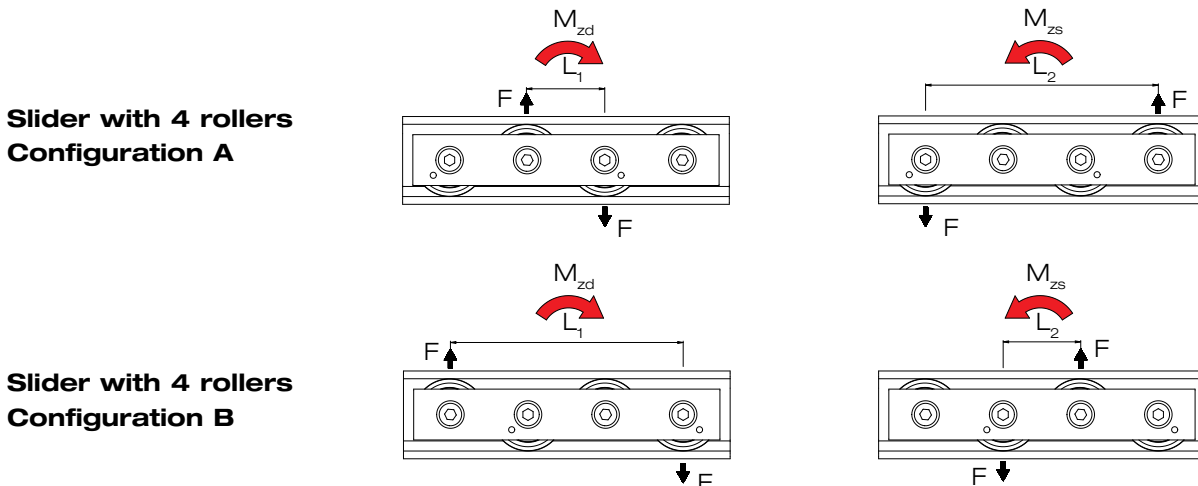

Two sliders under load moment M_z

If an overhanging load acts in an application with two sliders per rail and thus causes an M_z -moment in one direction, there are differing support reactions with the two sliders. For this reason, an optimal arrangement of different slider configurations to reach the maximum load capacities must be achieved for the application. In practice this means, when using NTE-, NUE- or CSW-sliders with 3 or 5 rollers, both sliders are installed rotated by 180° so that the slider is always loaded on the side with the most rollers (with NKE-sliders this is not possible due to the different raceway geometry). For an even number of rollers this has no effect. The CD-slider with installation option from above or below cannot be installed due to the position of the rollers in reference to the installation side therefore they are available in the configurations A and B.

CSW-slider under load moment M_z

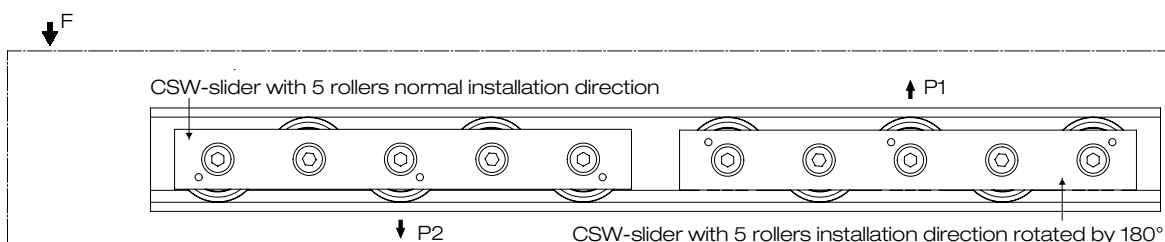

Linear Accuracy

Linear accuracy is defined as the maximum deviation of the slider in the rail based on the side and support surface during straight line movement. The linear accuracy, depicted in the graphs below, applies to rails that are carefully installed with all the provided screws on a level and rigid foundation.

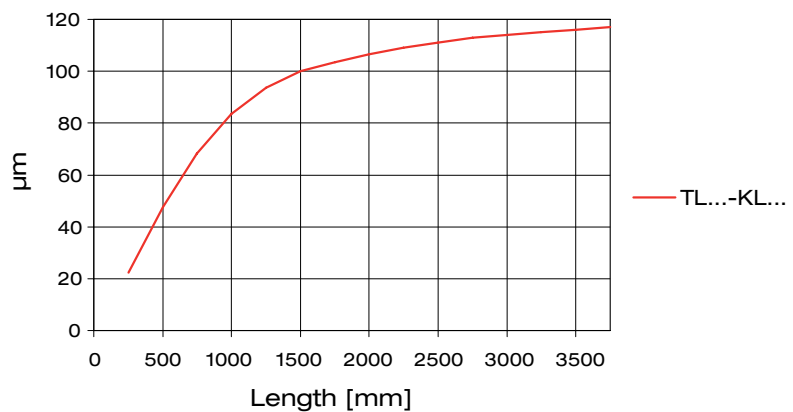
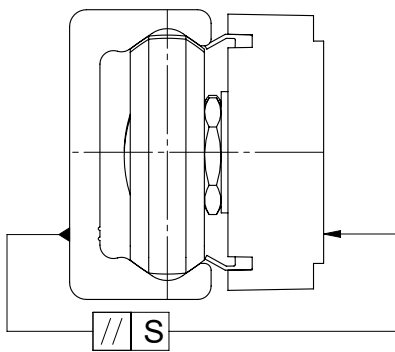
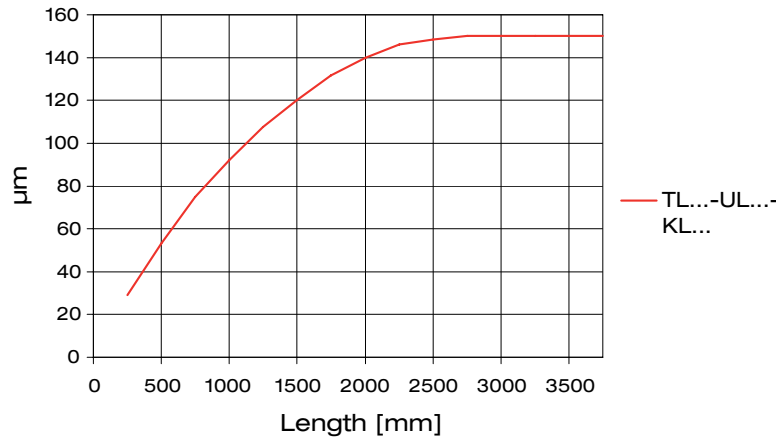
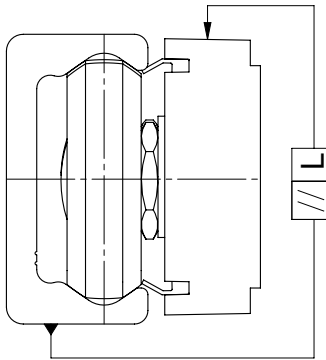

Deviation of accuracy with two 3 roller sliders in one rail

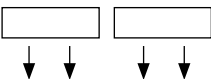
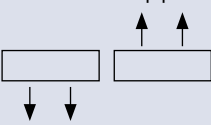
Type	TL..., UL..., KL...
ΔL (mm) Slider with equal arrangement 	0,2
ΔL (mm) Slider with opposite arrangement 	1,0
ΔS (mm)	0,05

T+U-system maximum offset

U-rails have flat parallel raceways that allow free lateral movement of the sliders. The maximum axial offset that can be compensated for in each slider of the U-rail is made up of the combined values S1 and S2. Considered from a nominal value B_{nom} as the starting point, S1 indicates the maximum offset into the rail, while S2 represents the maximum offset towards the outside of the rail.

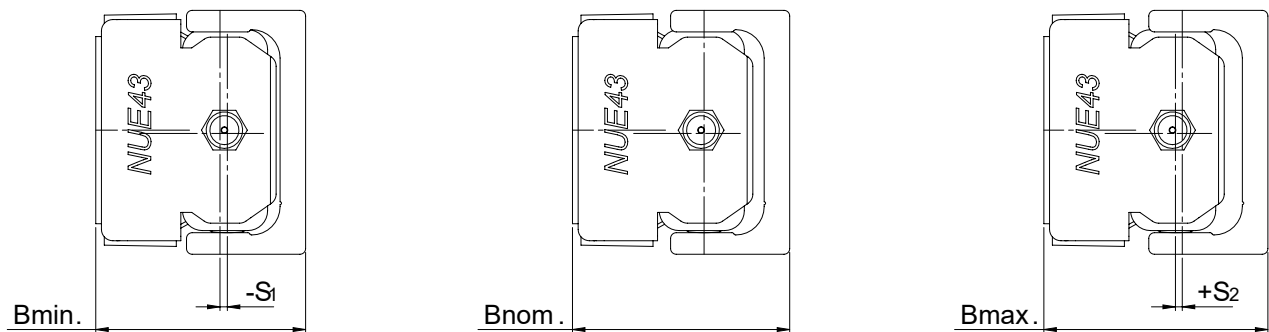

Slider type	S ₁	S ₂	B _{min} mm	B _{nom}	B _{max}
NU18	0	1,1	16,5	16,5	17,6
CSW18	0,3	1,1	14,7	15	16,1
NUE28	0	1,3	24	24	25,3
CSW28	0,6	1,3	23,3	23,9	25,2
NUE43	0	2,5	37	37	39,5
CSW43	1,4	2,5	35,6	37	39,5
NUE63	0	3,5	50,5	50,5	54
CSW63	0,4	3,5	49,4	49,8	53,3

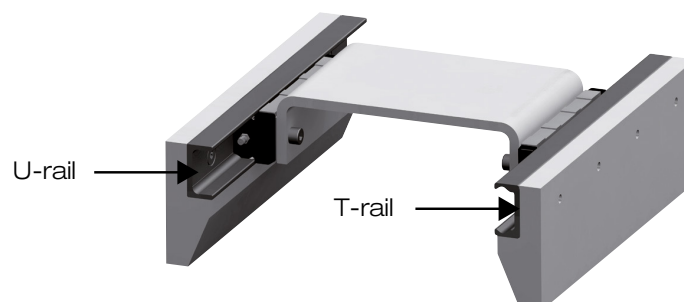

The application example in the adjacent drawing shows that the T+U-system implements a problem-free function of the slider even with an angled offset in the mounting surfaces.

If the length of the guide rails is known, the maximum allowable angle deviation of the screwed surfaces can be determined using this formula (the slider in the U-rail moves here from the innermost position S1 to outermost position S2):

$$\alpha = \arctan \frac{S^*}{L}$$

S* = sum of S1 and S2
L = length of rail

The following table contains guidelines for this maximum angle deviation α , achievable with the longest guide rail from one piece.

Size	Rail length mm	Offset S mm	Angle α (°)
18	2000	1,4	0,040
28	3200	1,9	0,034
43	4080	3,9	0,062
63	4080	3,9	0,062

The T+U-system can be designed in different arrangements. A T-rail accepts the vertical components of load P. A U-rail attached underneath the component to be guided prevents the vertical panel from swinging and is used as moment support. In addition a vertical offset in the structure, as well as possible existing unevenness of the support surface, is compensated for.

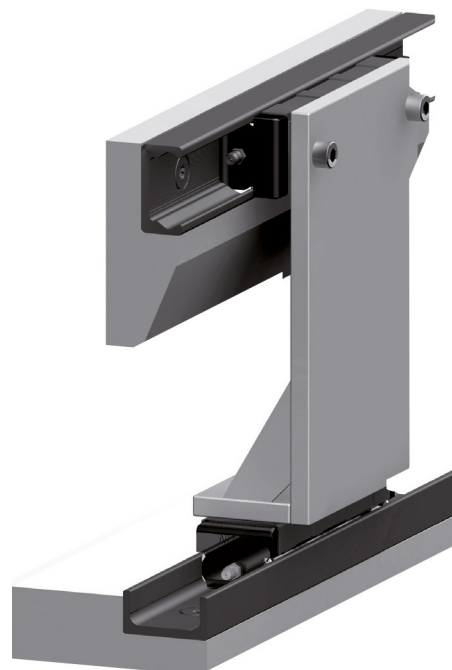
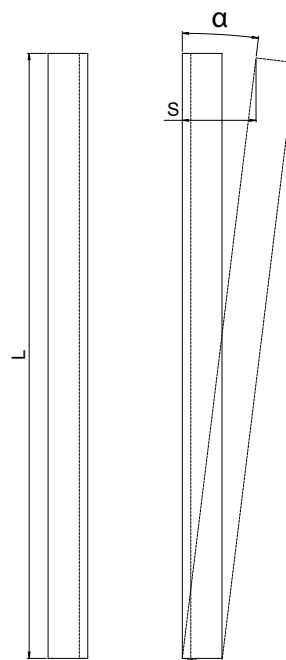
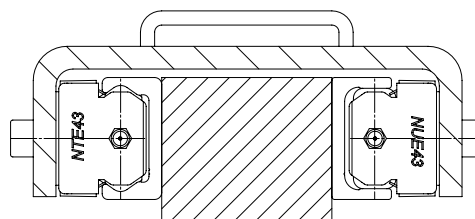

K + U-system Tolerance Compensation

Deviations in parallelism in two planes

The K+U-system, like the T+U-system, can compensate for axial deviations in parallelism. Additionally, the K+U system has the option of rotating the slider in the rail, which will compensate for other deviations in parallelism, e.g. height offset. The unique raceway contour of the K-rail allows the slider a certain rotation around its longitudinal axis, with the same linear precision as with a T-rail. With the use of a K+U-system, the K-rail accounts for the main loads and the motion of the track. The U-rail is used as a support bearing and takes only radial forces and Mz moments. The K-rail must always be installed so that the radial load of the slider is always supported by at least 2 load bearing roller sliders, which lie on the V-shaped raceway (reference line) of the rail.



Slider type	$\alpha_1(^{\circ})$	$\alpha_2(^{\circ})$
NKE43 and NUE43	2	2
NKE63 and NUE63	1	1

K-rails and sliders are available in both sizes 43 and 63. The custom NKE-slider may only be used in K-rails and cannot be exchanged with other Rollco sliders. The maximum allowable rotation angle of the NKE- and NUE-sliders are shown in the following table. α_1 is the maximum rotation angle counterclockwise, α_2 is clockwise.

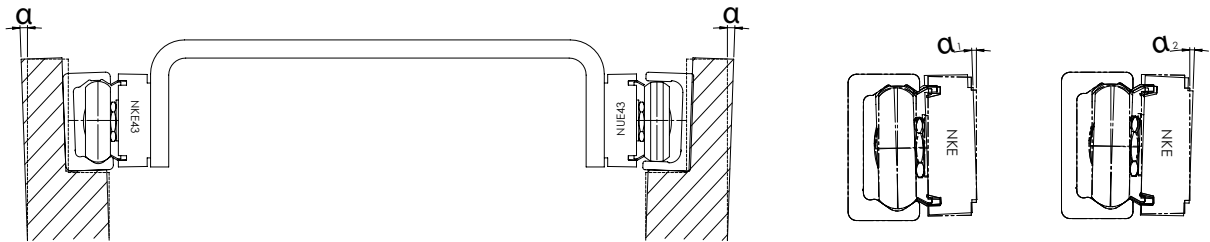

K+U-system maximum offset

If a K-rail is used in combination with a U-rail, with guaranteed problemfree running and without extreme slider load, a pronounced height difference between the two rails can also be compensated for. The following illustration shows the maximum height offset b of the mounting surfaces in relation to the distance a of the rails.

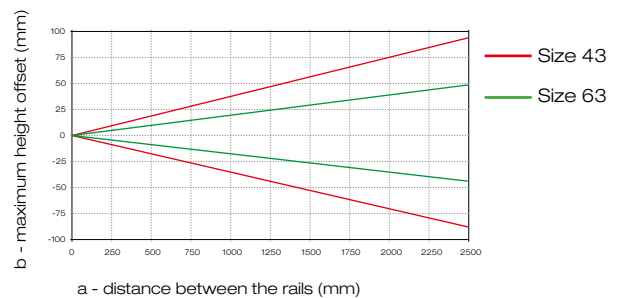
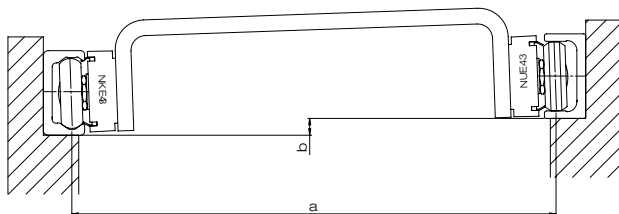

Static Load

The radial load capacity rating, C_{0rad} , the axial load capacity rating, C_{0ax} , and moments M_x , M_y , M_z indicate the maximum permissible values of the load. Higher loads will have a detrimental effect on the running quality. A safety factor, S_0 , is used to check the static load, which takes into account the basic parameters of the application and is defined more in detail in the following table:

Safety factor S_0

No shock nor vibration, smooth and low-frequency reverse, high assembly accuracy, no elastic deformations	1 - 1,5
Normal installation conditions	1,5 - 2
Shock and vibration, high-frequency reverse, significant elastic deformation	2 - 3,5

The ratio of the actual load to maximum permissible load may be as large as the reciprocal of the accepted safety factor, S_0 , at the most.

$$\frac{P_{0rad}}{C_{0rad}} \leq \frac{1}{S_0} \quad \frac{P_{0ax}}{C_{0ax}} \leq \frac{1}{S_0} \quad \frac{M_1}{M_x} \leq \frac{1}{S_0} \quad \frac{M_2}{M_y} \leq \frac{1}{S_0} \quad \frac{M_3}{M_z} \leq \frac{1}{S_0}$$

The above formulas are valid for a single load case. If two or more forces are acting simultaneously, please check the following formula:

$$\frac{P_{0rad}}{C_{0rad}} + \frac{P_{0ax}}{C_{0ax}} + \frac{M_1}{M_x} + \frac{M_2}{M_y} + \frac{M_3}{M_z} + y \leq \frac{1}{S_0}$$

- P_{0rad} = effective radial load (N)
- C_{0rad} = permissible radial load (N)
- P_{0ax} = effective axial load (N)
- C_{0ax} = permissible axial load (N)
- M_1, M_2, M_3 = external moments (Nm)
- M_x, M_y, M_z = maximum permissible moments in the different loading directions (Nm)
- y = reduction due to preload

The safety factor S_0 can lie on the lower given limit if the occurring forces can be determined with sufficient precision. If shock and vibration are present, the higher value should be selected. For dynamic applications higher safety is required. Please contact Rollco.

Fixing Holes

V-holes with 90° bevels

The selection of rails with 90° countersunk holes is based on the precise alignment of the threaded holes for installation. Here the complex alignment of the rail to an external reference is omitted, since the rail aligns during installation by the self-centering of the counter-sunk screws on the existing hole pattern.

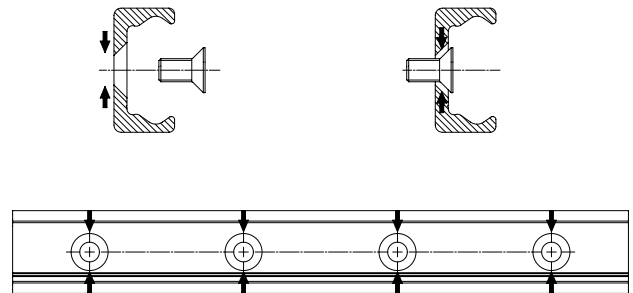

C-holes with cylindrical counterbore

The cylindrical screw has, as shown, some play in the countersunk fixing hole, so that an optimum alignment of the rail can be achieved during installation. The area T is the diameter of the possible offset, in which the screw center point can move during the precise alignment.

Rail type	Area T mm
TLC18 - ULC18	Ø 1,0
TLC28 - ULC28	Ø 1,0
TLC43 - ULC43 - KLC43	Ø 2,0
TLC63 - ULC63 - KLC63	Ø 1,0

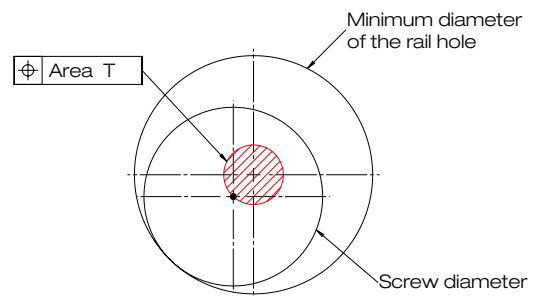

The minimum chamfers on the fixing threads are listed in the table below.

Size	Chamfer mm
18	0,5 x 45°
28	0,6 x 45°
43	1 x 45°
63	0,5 x 45°

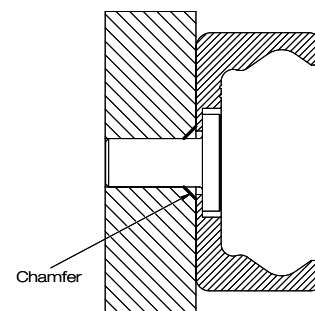

Example for fixing with Torx® screws (custom design)

Joined Rails

The maximum available rail length in one piece is indicated under Order Code Rail. Longer lengths are achieved by joining two or more rails (joined rails). Rollco then machines the rail ends at a right angle to the impact surfaces and marks them. Additional fixing screws are included with the delivery, which ensure a problem-free transition of the slider over the joints, if the installation procedures are followed.

Please see section **Installation of Joined Rails**.

Two additional threaded holes are required in the load-bearing structure. The included end fixing screws correspond to the installation screws for the rails for cylindrical counterbores. The alignment fixture for aligning the rail joint can be ordered using the designation given in the table.

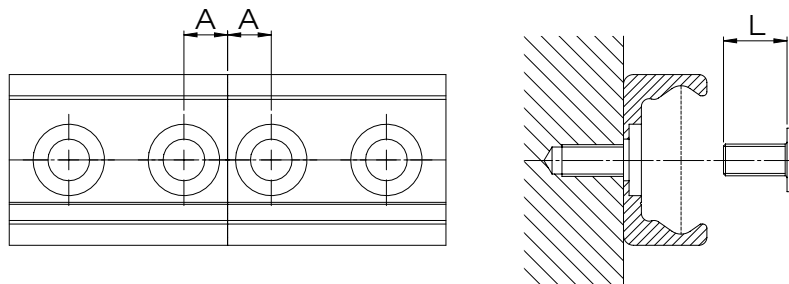

Rail type	A mm	Threaded hole (load-bearing structure)	L mm	Alignment fixture
T..., U... 18	7	M4	8	AT18
T..., U... 28	8	M5	10	AT28
T..., U... 43	11	M8	16	AT43
T..., U... 63	8	M8	20	AT63
K... 43	11	M8	16	AK43
K... 63	8	M8	20	AK63

Calculation Formulas

Examples

Formulas for determining the forces on the most heavily loaded slider.

Horizontal movement

Static test

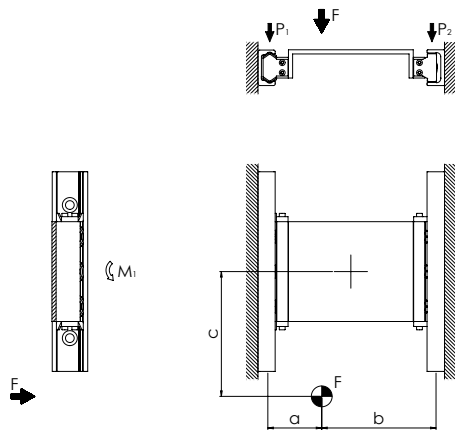

Slider load:

$$P_1 = F \cdot \frac{b}{a+b}$$

$$P_2 = F - P_1$$

In addition each slider is loaded by a moment:

$$M_1 = \frac{F}{2} \cdot c$$

Horizontal movement

Static test

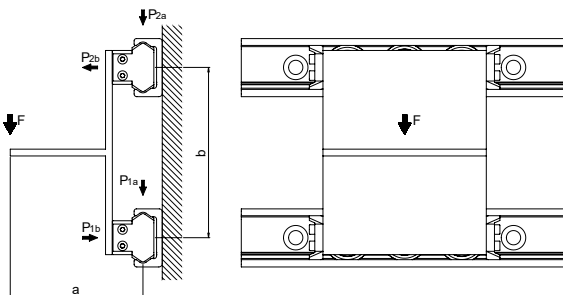

Slider load:

$$P_{1a} \approx P_{2a} = \frac{F}{2}$$

$$P_{2b} \approx P_{1b} = F \cdot \frac{a}{b}$$

Horizontal movement

Static test

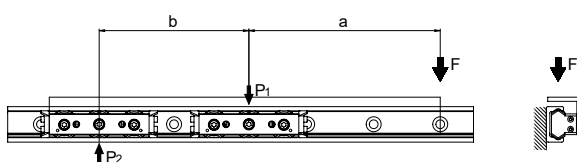

Slider load:

$$P_2 = F \cdot \frac{a}{b}$$

$$P_1 = P_2 + F$$

Horizontal movement

Static test

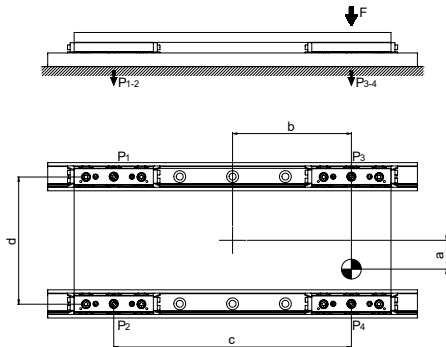

Note: It is defined that the slider no. 4 is always located closest to the point where the force is applied.

Slider load:

$$P_1 = \frac{F}{4} - \left(\frac{F}{2} \cdot \frac{b}{c}\right) - \left(\frac{F}{2} \cdot \frac{a}{d}\right)$$

$$P_2 = \frac{F}{4} - \left(\frac{F}{2} \cdot \frac{b}{c}\right) + \left(\frac{F}{2} \cdot \frac{a}{d}\right)$$

$$P_3 = \frac{F}{4} + \left(\frac{F}{2} \cdot \frac{b}{c}\right) - \left(\frac{F}{2} \cdot \frac{a}{d}\right)$$

$$P_4 = \frac{F}{4} + \left(\frac{F}{2} \cdot \frac{b}{c}\right) + \left(\frac{F}{2} \cdot \frac{a}{d}\right)$$

Vertical movement

Static test

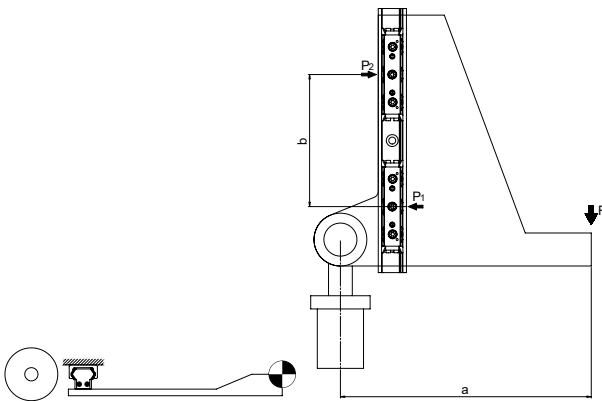

Slider load:

$$P_1 \approx P_2 = F \cdot \frac{a}{b}$$

Horizontal movement

Static test

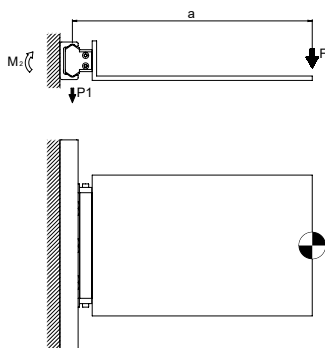

Slider load:

$$P_1 = F$$

$$M_2 = F \cdot a$$

Explanation of the calculation formula

- F = effective force (N)
- F_g = weight-force (N)
- P₁, P₂, P₃, P₄ = effective load on the slider (N)
- M₁, M₂ = effective moment (Nm)
- m = mass (kg)

Service life

The dynamic load capacity C is a conventional variable used for calculating the service life. This load corresponds to a nominal service life of 100 km. For values of the individual slider. The following formula links the calculated theoretical service life to the dynamic load capacity and the equivalent load:

$$L_{km} = 100 \cdot \left(\frac{C}{P} \cdot \frac{f_c}{f_i} \cdot f_h \right)^3$$

- L_{km} = theoretical service life(km)
- C = dynamic load capacity (N)
- P = effective equivalent load (N)
- f_c = contact factor (N)
- f_i = application coefficient
- f_h = stroke factor

The equivalent load P corresponds in its effects to the sum of the forces and moments working simultaneously on a slider. If these different load components are known, P results as follows:

$$P = P_1 + \left(\frac{P_a}{C_{0ax}} + \frac{M_1}{M_x} + \frac{M_2}{M_y} + \frac{M_3}{M_z} \right) \cdot C_{0rad}$$

Here the external loads are assumed as constant in time. Brief loads, which do not exceed the maximum load capacities, do not have any relevant effect on the service life and can therefore be neglected. The contact factor f_c refers to applications in which several sliders pass the same rail section. If two or more sliders move over the same point of a rail, the contact factor to be taken into account in the formula for calculation of the service life.

Number of sliders	1	2	3	4
f_c	1	0,8	0,7	0,63

The application coefficient f_i takes into account the operational conditions in the service life calculation. It has a similar significance to the safety factor S_0 in the static load test. It is calculated as described in the following table:

Neither shocks nor vibrations, smooth and low-frequency direction change; clean operating conditions; low speeds (<1 m/s)	1 - 1,5
Slight vibrations, average speeds (1 - 2,5 m/s) and average frequency of direction change	1,5 - 2
Shocks and vibrations, high speeds (>2,5 m/s) and high-frequency direction change, extreme dirt contamination	2 - 3,5

The stroke factor f_h takes into account the higher load of the raceways and rollers during short strokes on the same total length of run. The corresponding values are taken from the following graph (for strokes longer than 1 m, $f_h = 1$):

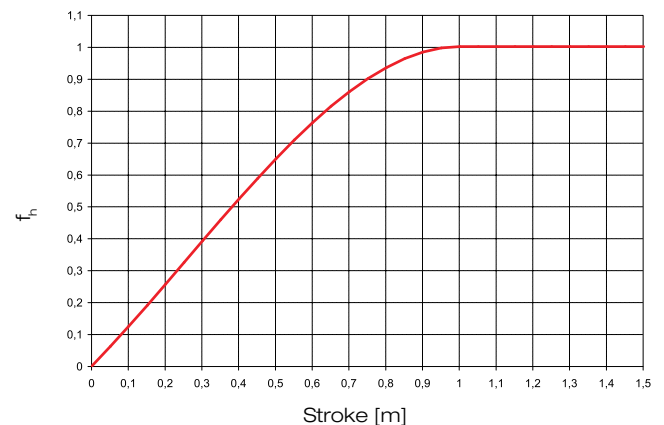

Installation Instructions

Adjusting the Sliders

Normally the linear guides are delivered as a system consisting of rail and adjusted sliders. If rail and slider are delivered separately or if the slider is installed in another raceway, the preload must be set again.

Setting the preload:

1. Check the cleanliness of the tracks.
2. Insert the slider in the rail (CSW sliders should be inserted without wipers). Slightly loosen the fixing screws of the roller pins to be adjusted.
3. Position the slider on one end of the rail.
4. For the U rails there must be a thin support (e.g. set key) under the ends of the slider body to ensure the horizontal alignment of the slider in the flat raceways.
5. Insert the flat key on the side with the triangular symbol combined with a red mark of the screw head (N-series slider), or on the side with a circle symbol (CSW-slider) between rail and slider.
6. By turning the flat key clockwise, the roller to be adjusted is pressed against the upper track and the slider is then without play. Avoid a preload that is too high. It generates increased wear and reduces the service life.
7. While holding the correct position of the roller pin with the adjustment key, the fixing screw can be carefully tightened. The exact tightening torque will be checked later.
8. Move the slider in the rail and check the preload over the entire length of the rail. It should move easily and the slider should not have play at any location of the rail.
9. For sliders with more than 3 rollers, repeat this process with each eccentric roller pin. Always start with the first roller pin after the one with the red marking. Make sure that all roller pins have uniform contact to the raceways.
10. Now tighten the fixing screws with the specified tightening torque from the table while the flat key holds the angle adjustment of the pin. A special thread in the roller pin secures the set position.
11. Now install the wiper of the CSW-sliders and ensure a proper lubrication of the raceways.

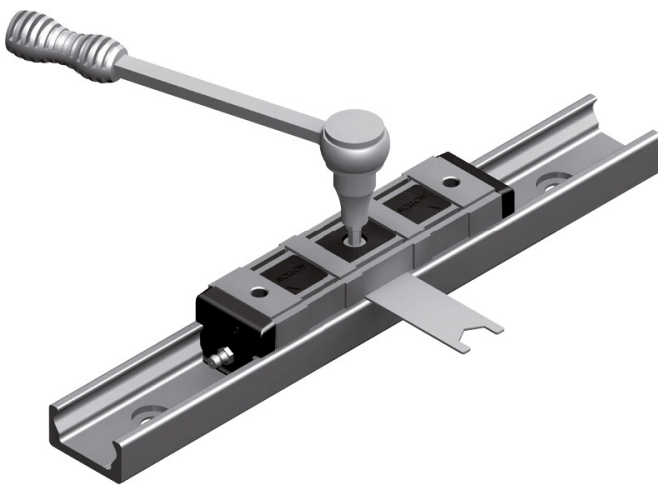

Slider size	Tightening torque Nm
18	3
28	7
43	12
63	35

Use of radial ball bearings

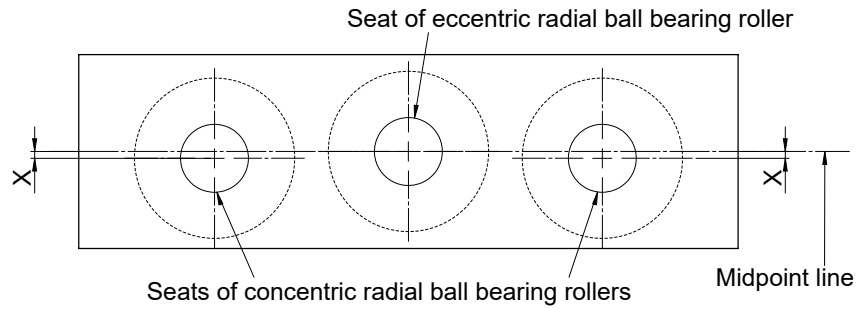

Slider size	x (mm)
18	0.40
28	0.45
43	0.60
63	0.55

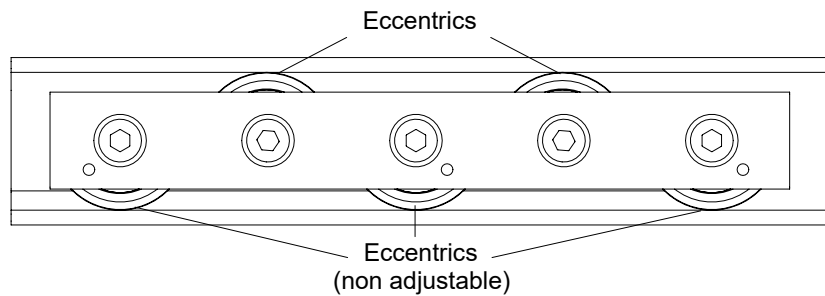

Rail installation with reference surface as support

1. Remove unevenness, burrs and dirt from the support surface.
2. Press the rail against the support surface and insert all screws without tightening them.
3. Start tightening the fixing screws to the specified torque on one end of the rail while continuing to hold pressure on the rail against the support surface.

Screw type	Tightening torque Nm
M4 (T..., U... 18)	3
M5 (T..., U... 28)	9
M8 (T..., U..., K... 43)	22
M8 (T..., U..., K... 63)	35

Installation of Joined Rails

After the fixing holes for the rails are made in the load-bearing structure, the joined rails can be installed according to the following procedure:

1. Fix the individual rails on the mounting surface by tightening all screws except for each last one on the rail joint.
2. Install the end fixing screws without tightening them.
3. Place the alignment fixture on the rail joint and tighten both set screws uniformly, until the raceways are aligned.
4. After the previous step (3) it must be checked if both rail backs lie evenly on the mounting surface. If a gap has formed there, this must be shimmed.
5. The bottom of the rails should be supported in the area of the transition. Here a possible existing gap must be looked for, which must be closed if necessary for correct support of the rail ends by shims.
6. Insert the key through the holes in the alignment fixture and tighten the screws on the rail ends.
7. For rails with 90° countersunk holes, tighten the remaining screws starting from the rail joint in the direction of the rail center. For rails with cylindrical counter-sunk holes, first adjust the rail to an external reference, then proceed as described above.
8. Remove the alignment fixture from the rail.

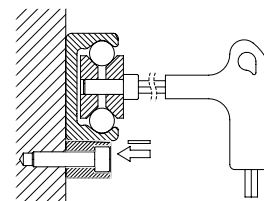
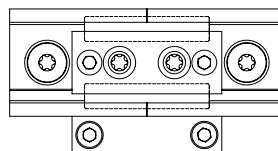
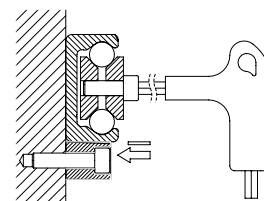
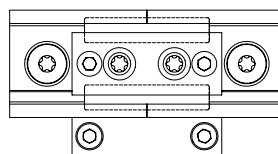
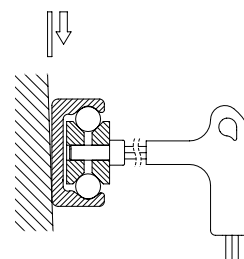
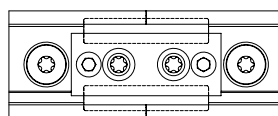
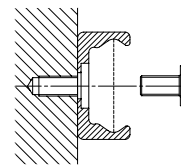
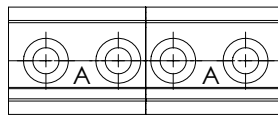

Remarks

- The sliders are equipped with rollers that are in alternating contact with both sides of the raceway. Markings on the body around the roller pins indicate correct arrangement of the rollers to the external load.
- By a simple adjustment of the eccentric rollers, the slider has clearance set by the desired preload in the rail.
- Rails in joined design are available for longer transverse distances.
- The K-rails are not suitable for vertical installation.
- Screws of property class 10.9 must be used.
- Differences in screw sizes must be observed.
- Ensure that the fixing holes of the adjacent construction are sufficiently countersunk during rail installation.

Operating Conditions

Corrosion Protection

The Compact Rail product family has a standard corrosion protection system by means of electrolytic-zinc plating according to ISO 2081. If increased corrosion protection is required, application-specific surface treatments are available upon request, e.g. as nickel-plated design with FDA approval for use in the food industry. For more information contact Rollco.

Speed and Acceleration

The Compact Rail product family is suitable for high operating speeds and accelerations.

Size	Speed (m/s)	Acceleration (m/s ²)
18	3	10
28	5	15
43	7	15
63	9	20

Operating Temperatures

The temperature range for continuous operation is: -30 °C / +120 °C with occasional peaks up to +150 °C. Peaks up to +170 °C can also be reached with the use of CSW-series sliders (except size 63) not equipped with polyamide wipers.

Preload

Preload classes

The factory installed systems, consisting of rails and sliders, are available in two preload classes:

- Standard preload K1 means a rail-slider combination with minimum preload which means the rollers are adjusted free of clearance for optimal running properties.
- Usually preload K2 is used for rail-slider systems for increasing the rigidity. When using a system with K2 preload a reduction of the loading capacities and service life must be taken into consideration (see table below).

This coefficient γ is used in the calculation formula for checking the static load and lifetime (see section **Static Load**). The interference is the difference between the contact lines of the rollers and the raceways of the rail.

Preload class	Reduction γ	Interference* (mm)	Rail type
K1	-	0.01	all
K2	0.1	0.03	T, U...18
		0.04	T, U...28
		0.05	T, U...35
		0.06	T, U, K...43, T, U, K...63

* Measured on the largest interior dimension between the raceways

Maintenance

Roller Lubrication

The bearings inside the rollers are lubricated for life. Custom lubrication of the roller sliders for use in high temperature environments or in the food industry is available upon request. For more information, please contact Rollco.

Lubrication of the Raceways

Proper lubrication during normal conditions:

- reduces friction
- reduces wear
- reduces the load of the contact surfaces through elastic deformations
- reduces running noise

To reach the calculated service life a film of lubricant should always be present between the raceway and roller. This also serves to protect against corrosion of the ground raceways.

N-slider Lubrication

Lubrication when using N-sliders

NTE-, NUE- and NKE-sliders (except for types NT/NU18) are equipped with a self-lubrication kit for periodic lubrication of the slider. This provides a progressive release of lubricant on the raceway way during operation of the slider. The expected service life is up to 2 million cycles, depending on the type of application. The zerk fittings provide the lubrication.

Lubricant	Thickening agent	Temperature range (°C)	Dynamic viscosity (mPas)
Mineral oil	Lithium soap	-30... to + 120	1000

CSW-slider Lubrication

Lubrication when using CSW-sliders

The CSW series sliders can be provided with wipers made of polyamide, to remove the contaminants on the raceways. Since the sliders do not have a self-lubrication kit, manual lubrication of the raceways is required. A guideline is to lubricate the raceways every 100 km or every 6 months. We recommend a roller bearing lubricant with a lithium base of average consistency as a lubricant.

Lubricant	Thickening agent	Temperature range (°C)	Dynamic viscosity (mPas)
Roller bearing lubricant	Lithium soap	-30 to + 170	4500

Rollco Products

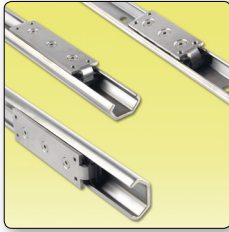

C-RAIL

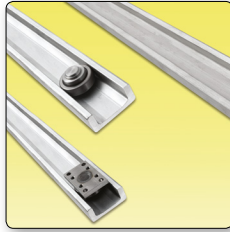

U-RAIL

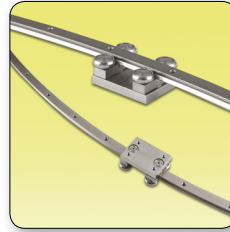

CURVI LINE

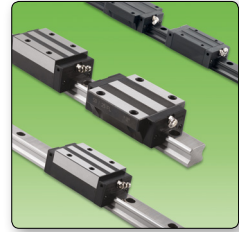

LINEAR RAIL SBI

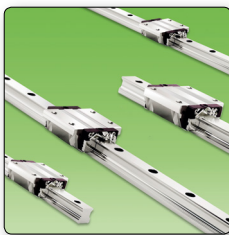

**LINEAR RAIL
BALL CHAIN**

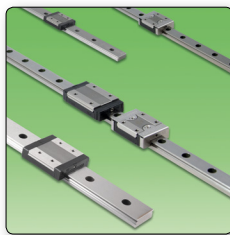

**LINEAR MINIATURE
GUIDE**

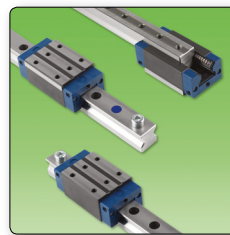

**LINEAR ROLLER
GUIDE**

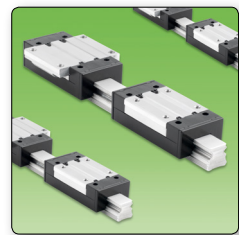

**LINEAR RAIL
ALUMINIUM**

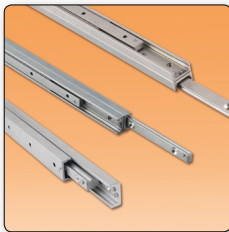

**TELESCOPIC RAIL
HEAVY**

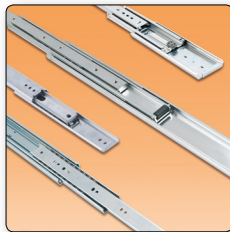

**TELESCOPIC RAIL
LIGHT**

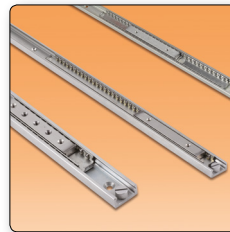

EASYSLIDE

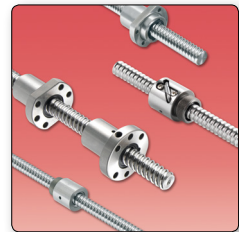

BALL SCREWS

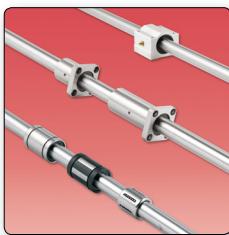

**BALL BEARINGS
& STEEL SHAFTS**



LINEAR UNIT RHL

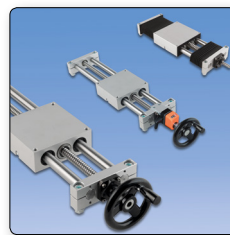

LINEAR UNIT QME

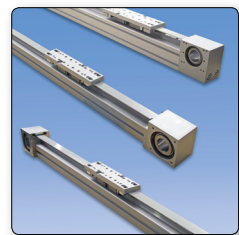

LINEAR UNIT E-SMART

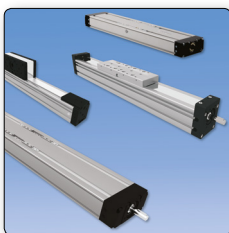

LINEAR UNITS CT & MT

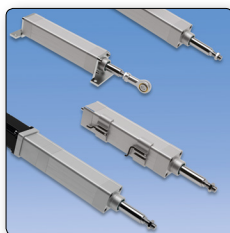

**PNCE ELECTRO-
MECHANICAL CYLINDERS**

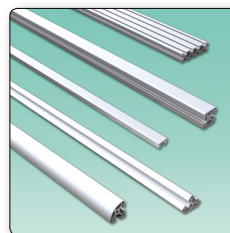

ALUMINIUM PROFILES



BELT CONVEYORS

Rollco AB
Box 22234
Ekvändan 3
250 24 Helsingborg
Sweden
Tel. +46 42 150040
Fax +46 42 150045
www.rollco.se

Rollco A/S
Skomagervej 13 E
7100 Vejle
Denmark
Tel. +45 7552 2666
Fax +45 7552 0708
www.rollco.dk

Rollco Oy
Sarankulmankatu 12
33900 Tampere
Finland
Tel. +358 207 57 97 90
Fax +358 207 57 97 99
www.rollco.fi

Rollco Norge AS
Industrigata 6
3414 Lierstrada
Norway
Tel. +47 32 84 00 34
Fax +47 32 84 00 91
www.rollco.no

Rollco Taiwan
No. 28, Lane 125, Da-an Road
Shulin District 238
New Taipei City, Taiwan
Tel. +886-2-8687-2726
Fax +886-2-8687-2720
www.rollco-tw.com

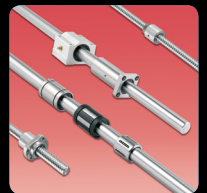
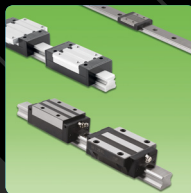

ROLLCO
SPECIALIZED
ON LINEAR MOTION