

2638A

HYDRA Series III Data Acquisition Unit

Calibration Manual

August 2014

© 2014 Fluke Corporation. All rights reserved. Specifications are subject to change without notice.
All product names are trademarks of their respective companies.

LIMITED WARRANTY AND LIMITATION OF LIABILITY

Each Fluke product is warranted to be free from defects in material and workmanship under normal use and service. The warranty period is one year and begins on the date of shipment. Parts, product repairs, and services are warranted for 90 days. This warranty extends only to the original buyer or end-user customer of a Fluke authorized reseller, and does not apply to fuses, disposable batteries, or to any product which, in Fluke's opinion, has been misused, altered, neglected, contaminated, or damaged by accident or abnormal conditions of operation or handling. Fluke warrants that software will operate substantially in accordance with its functional specifications for 90 days and that it has been properly recorded on non-defective media. Fluke does not warrant that software will be error free or operate without interruption.

Fluke authorized resellers shall extend this warranty on new and unused products to end-user customers only but have no authority to extend a greater or different warranty on behalf of Fluke. Warranty support is available only if product is purchased through a Fluke authorized sales outlet or Buyer has paid the applicable international price. Fluke reserves the right to invoice Buyer for importation costs of repair/replacement parts when product purchased in one country is submitted for repair in another country.

Fluke's warranty obligation is limited, at Fluke's option, to refund of the purchase price, free of charge repair, or replacement of a defective product which is returned to a Fluke authorized service center within the warranty period.

To obtain warranty service, contact your nearest Fluke authorized service center to obtain return authorization information, then send the product to that service center, with a description of the difficulty, postage and insurance prepaid (FOB Destination). Fluke assumes no risk for damage in transit. Following warranty repair, the product will be returned to Buyer, transportation prepaid (FOB Destination). If Fluke determines that failure was caused by neglect, misuse, contamination, alteration, accident, or abnormal condition of operation or handling, including overvoltage failures caused by use outside the product's specified rating, or normal wear and tear of mechanical components, Fluke will provide an estimate of repair costs and obtain authorization before commencing the work. Following repair, the product will be returned to the Buyer transportation prepaid and the Buyer will be billed for the repair and return transportation charges (FOB Shipping Point).

THIS WARRANTY IS BUYER'S SOLE AND EXCLUSIVE REMEDY AND IS IN LIEU OF ALL OTHER WARRANTIES, EXPRESS OR IMPLIED, INCLUDING BUT NOT LIMITED TO ANY IMPLIED WARRANTY OF MERCHANTABILITY OR FITNESS FOR A PARTICULAR PURPOSE. FLUKE SHALL NOT BE LIABLE FOR ANY SPECIAL, INDIRECT, INCIDENTAL, OR CONSEQUENTIAL DAMAGES OR LOSSES, INCLUDING LOSS OF DATA, ARISING FROM ANY CAUSE OR THEORY.

Since some countries or states do not allow limitation of the term of an implied warranty, or exclusion or limitation of incidental or consequential damages, the limitations and exclusions of this warranty may not apply to every buyer. If any provision of this Warranty is held invalid or unenforceable by a court or other decision-maker of competent jurisdiction, such holding will not affect the validity or enforceability of any other provision.

Fluke Corporation
P.O. Box 9090
Everett, WA 98206-9090
U.S.A.

Fluke Europe B.V.
P.O. Box 1186
5602 BD Eindhoven
The Netherlands

Table of Contents

Title	Page
Introduction.....	1
Contact Fluke	1
Safety Information	2
General Specifications	5
Measurement Specifications	6
DC Voltage	6
DC Voltage Input Characteristics	6
DC Voltage Accuracy	7
DC Voltage Additional Errors.....	7
AC Voltage	7
AC Voltage Input Characteristics.....	8
AC Voltage Accuracy.....	8
Additional Low Frequency Errors	8
DC Current	8
DC Current Input Characteristics.....	9
DC Current Accuracy.....	9
DC Current Additional Errors	9
AC Current.....	9
AC Current Input Characteristics	9
AC Current Accuracy	10
Additional Low Frequency Errors	10
Frequency.....	10
Resistance.....	10
Resistance Input Characteristics	11
Resistance Accuracy	11
Resistance Additional Errors	11
RTD	11
RTD Temperature Accuracy	12
RTD Measurement Characteristics	12
Thermistor	12
Thermistor Temperature Accuracy	12
Thermistor Measurement Characteristics.....	13
Thermocouple.....	13
Thermocouple Temperature Accuracy	13
Thermocouple Measurement Characteristics	14
Digital I/O.....	14

Totalizer.....	14
Trigger.....	15
Alarm Output.....	15
2638A-100 Universal Input Module.....	15
General Maintenance.....	16
If the Product Does Not Turn On.....	16
Clean the Product.....	16
Replace the Line Power Fuse.....	16
Battery Replacement.....	17
Memory and Factory Reset.....	18
Required Equipment.....	19
Test Considerations.....	21
Performance Tests.....	21
Front Panel Test.....	22
DC Volts Verification.....	22
Volts AC and Frequency Verification.....	24
4-Wire Ohms Verification.....	26
PRT Verification Steps.....	27
Configure Resistance Display.....	27
Thermistor Verification Steps.....	28
Configure Resistance Display.....	28
DC Current Verification.....	29
AC Current Verification Steps.....	31
2638A-100 Module Verification.....	32
Calibration Adjustment.....	33
Unlock the Product.....	33
Unlock the Product with a Remote Interface.....	33
Reset the Admin Password.....	34
Disassembly.....	35
Change the Calibration Date Remotely.....	37
“Mainframe” Adjustment Process.....	37
Remote Commands for Calibration.....	43
Remote Programming Examples.....	44
Start a Full Calibration.....	44
Calibrate 1 V DC Range only.....	45
Write Calibration Date to a Module.....	45
Command References.....	46
User-Replaceable Parts and Accessories.....	51

List of Tables

Table	Title	Page
1.	Symbols.....	2
2.	Fuses.....	16
3.	Memory Clear Functions	18
4.	Required Test Equipment.....	19
5.	DC Volts Verification Steps	23
6.	AC Volts Verification Steps	25
7.	AC Volts Frequency Verification Steps	25
8.	4-Wire Ohms Verification Steps	26
9.	PRT Verification Steps	27
10.	Thermistor Verification Steps	28
11.	DC Current Verification Steps	30
12.	AC Current Verification Steps	32
13.	Adjustment Steps	37
14.	List of Commands	43
15.	Full Calibration Example	44
16.	1 V DC Calibration Example.....	45
17.	Write Calibration Date to a Module Example	45
18.	User-Replaceable Parts and Accessories.....	51

List of Figures

Figure	Title	Page
1.	Fuse Replacement	17
2.	DC Voltage Test Connections	22
3.	AC Volts Verification Connections.....	24
4.	4-Wire Ohms Test Equipment Setup.....	26
5.	PRT Verification Connection	27
6.	Thermistor Test Equipment Setup.....	28
7.	mA DC Current Equipment Setup	29
8.	mA AC Current Equipment Setup	31
9.	Password Reset Jumper	34
10.	Disassembly	36
11.	Replaceable Parts	52

Introduction

The Fluke 2638A HYDRA Series III Data Acquisition Unit (the Product or Instrument) is a 67 analog channel bench-top data logger that measures and records dc volts, ac volts, dc current, ac current, resistance, frequency, and temperature. See the *Specifications* section for information on the types and ranges of the measurement inputs the Product can accept.

Contact Fluke

To contact Fluke, call one of the following telephone numbers:

- Technical Support USA: 1-800-44-FLUKE (1-800-443-5853)
- Calibration/Repair USA: 1-888-99-FLUKE (1-888-993-5853)
- Canada: 1-800-36-FLUKE (1-800-363-5853)
- Europe: +31 402-675-200
- Japan: +81-3-6714-3114
- Singapore: +65-6799-5566
- Anywhere in the world: +1-425-446-5500

Or, visit Fluke's website at www.fluke.com.

To register your product, visit <http://register.fluke.com>.













To view, print, or download the latest manual supplement, visit <http://us.fluke.com/usen/support/manuals>.

Safety Information

A **Warning** identifies conditions and procedures that are dangerous to the user.
A **Caution** identifies conditions and procedures that can cause damage to the Product or the equipment under test.

See Table 1 for a list of symbols used in this manual and on the Product.

Table 1. Symbols

Symbol	Description	Symbol	Description
	Risk of Danger. Important information. See Manual.		DC (Direct Current)
	Hazardous voltage. Risk of electric shock.		AC or DC (Alternating or Direct Current)
	Earth ground		Digital signal
	AC or DC (Alternating or Direct Current)		Double insulated
	Recycle		Power ON / OFF
	Conforms to relevant South Korean EMC Standards.		Conforms to European Union directives.
CAT II	Measurement Category II is applicable to test and measuring circuits connected directly to utilization points (socket outlets and similar points) of the low-voltage MAINS installation.		
CAT III	Measurement Category III is applicable to test and measuring circuits connected to the distribution part of the building's low-voltage MAINS installation.		
CAT IV	Measurement Category IV is applicable to test and measuring circuits connected at the source of the building's low-voltage MAINS installation.		
	This product complies with the WEEE Directive (2002/96/EC) marking requirements. The affixed label indicates that you must not discard this electrical/electronic product in domestic household waste. Product Category: With reference to the equipment types in the WEEE Directive Annex I, this product is classed as category 9 "Monitoring and Control Instrumentation" product. Do not dispose of this product as unsorted municipal waste. Go to Fluke's website for recycling information.		

⚠⚠ Warning

To prevent possible electrical shock, fire, or personal injury:

- Read all safety information before you use the Product.
- Carefully read all instructions.
- Use the Product only as specified, or the protection supplied by the Product can be compromised.
- Examine the case before you use the Product. Look for cracks or missing plastic. Carefully look at the insulation around the terminals.
- Do not use the Product if it operates incorrectly.
- Do not use the Product if it is damaged.
- Disable the Product if it is damaged.
- Use only the mains power cord and connector approved for the voltage and plug configuration in your country and rated for the Product.
- Replace the mains power cord if the insulation is damaged or if the insulation shows signs of wear.
- Make sure the ground conductor in the mains power cord is connected to a protective earth ground. Disruption of the protective earth could put voltage on the chassis that could cause death.
- Do not put the Product where access to the mains power cord is blocked.
- Use only correct measurement category (CAT), voltage, and amperage rated probes, test leads, and adapters for the measurement.
- Use only cables with correct voltage ratings.
- Do not use test leads if they are damaged. Examine the test leads for damaged insulation and measure a known voltage.
- Do not exceed the Measurement Category (CAT) rating of the lowest rated individual component of a Product, probe, or accessory.
- Keep fingers behind the finger guards on the probes.
- Do not apply more than the rated voltage, between the terminals or between each terminal and earth ground.
- Do not touch voltages >30 V ac rms, 42 V ac peak, or 60 V dc.
- Limit operation to the specified measurement category, voltage, or amperage ratings.
- Measure a known voltage first to make sure that the Product operates correctly.

- **Consider all accessible channels to be hazardous live and an electric shock hazard if any channel is connected to a hazardous voltage source.**
- **Do not remove, touch, or change the internal wiring of hazardous inputs until the input source is turned off.**
- **Remove inputs from hazardous voltage sources before an input module is opened.**
- **Use the correct terminals, function, and range for measurements.**
- **Use this Product indoors only.**
- **Do not use the Product around explosive gas, vapor, or in damp or wet environments.**

General Specifications

Mains Voltage

100 V Setting	90 V to 110 V
120 V Setting	108 V to 132 V
220 V Setting	198 V to 242 V
240 V Setting	216 V to 264 V

Frequency 47 Hz to 440 Hz

Power Consumption 36 VA peak (24 W average)

Environment Temperature

Operating	0 °C to 50 °C
Full accuracy	18 °C to 28 °C
Storage	-20 °C to 70 °C
Warm-up	1 hour to full accuracy specifications

Relative Humidity (non-condensing)

Operating	0 °C to 28 °C <90 %
	28 °C to 40 °C <75 %
	40 °C to 50 °C <45 %
Storage	-20 °C to 70 °C <95 %

Altitude

Operating	2,000 m
Storage	12,000 m

Vibration and Shock Complies with MIL-PRF-28800F Class 3

Channel Capacity

Total analog channels	67
Voltage/resistance channels	61
Current channels	7
Digital I/O	8 bits
Totalizer	1
Alarm outputs	6
Trigger input	1

Safety Protection

Mains Input	IEC 61010-1, Overvoltage Category II, Pollution Degree 2
Front Panel	300 V CAT II
Rear Panel	150 V CAT II, 250 V rms with maximum transient voltage of 1000 V peak. These terminals are not intended for connection to mains voltage above 150 V without external transient suppression. The maximum input that can be applied between rear-module terminals or between any rear-module terminal and earth ground is 250 V dc or ac rms.

Electromagnetic Environment IEC 61326-1: Basic (Controlled EM for full specification)

Radio Frequency Emissions IEC CISPR 11: Group 1, Class A. (Group 1 has intentionally generated and/or uses conductively coupled radio-frequency energy which is necessary for the internal functioning of the equipment itself. Class A equipment is suitable for use in non-domestic locations and/or directly connected to a low-voltage power supply network.)

Electromagnetic Compatibility Applies to use in Korea only. Class A Equipment (Industrial Broadcasting & Communication Equipment)^[1]
 [1] This product meets requirements for industrial (Class A) electromagnetic wave equipment and the seller or user should take notice of it. This equipment is intended for use in business environments and is not to be used in homes.

Math Channels

Number of channels	20
Operations	sum, difference, multiply, divide, polynomial, power, square root, reciprocal, exponential, logarithm, absolute value, average, maximum, minimum

Triggers interval, external (trigger input), alarm, remote (bus), manual

Battery life 5 years

Memory

Scan data RAM.....	75,000 readings with timestamp
Data/Setup flash memory	20 MB
Non-volatile memory life	5 years

USB Host Port

Standard	2.0, full speed
Connector type	Type A
Function	Memory
File system.....	FAT32
Memory capacity.....	32 GB

USB Device Port

Connector type	Type B
Class.....	Instrument
Function.....	Control and data transfer
Command protocol	SCPI

LAN

Function	Control and data transfer
Network protocols	Ethernet 10/100, TCP/IP
Command protocol	SCPI

Dimensions

Height	150 mm
Width.....	245 mm
Depth	385 mm
Weight.....	6 kg (typical configuration)
Shipping Weight.....	9.5 kg (typical configuration)

Conformity..... CE, CSA, IEC 61010 3rd ed.

Measurement Specifications

Accuracy specifications generally are valid for 6 ½ digit resolution mode (unless otherwise noted) for front panel input (Channel 001), after a minimum of 1-hour warm-up, and within an environment temperature range of 18 °C to 28 °C. 24-hour specifications are relative to calibration standards and assume a controlled electromagnetic environment per EN 61326. The confidence level for accuracy specifications is 99 % within 1 year of calibration (unless otherwise noted).

Scan rate (typical, depending on function and range)

Fast.....	46 channels per second max (0.02 seconds per channel)
Medium	10 channels per second (0.1 seconds per channel)
Slow	2 channels per second (0.5 seconds per channel)

Display Resolution..... 4 ½ to 6 ½ digits, depending on Sample Rate or NPLC

DC Voltage

Maximum Input..... 300 V on any range

Common Mode Rejection..... 140 dB at 50 Hz or 60 Hz (1 kΩ unbalance for NPLC of 1 or greater, ±500 V peak maximum in the low lead)

Normal Mode Rejection..... 55 dB for NPLC of 1 or greater and power-line frequency ±0.1 %, ±20 % of range peak maximum

Measurement Method..... Multi-ramp A/D

A/D Linearity..... 2 ppm of measurement + 1 ppm off range

Input Bias Current..... <30 pA at 25 °C

DC Voltage Input Characteristics

Range	Resolution	Resolution			Input Impedance
		Fast 4½ Digits	Medium 5 ½ Digits	Slow 6 ½ Digits	
100 mV	100.0000 mV	10 μV	1 μV	0.1 μV	10 MΩ or >10 GΩ ^[1]
1 V	1.000000 V	100 μV	10 μV	1 μV	10 MΩ or >10 GΩ ^[1]
10 V	10.00000 V	1 mV	100 μV	10 μV	10 MΩ or >10 GΩ ^[1]
100 V	100.0000 V	10 mV	1 mV	100 μV	10 MΩ ±1 %
300 V	300.000 V	100 mV	10 mV	1 mV	10 MΩ ±1 %

Note:

Input beyond ±12 V is clamped. The clamp current is up to 3 mA. 10 MΩ is default input impedance.

DC Voltage Accuracy

Accuracy is given as ± (% measurement + % of range).

Range	24 Hour (23 ±1 °C)	90 Days (23 ±5 °C)	1 Year (23 ±5 °C)	T.C./ °C Outside 18 °C to 28 °C
100 mV	0.0025 % + 0.003 %	0.0025 % + 0.0035 %	0.0037 % + 0.0035 %	0.0005 % + 0.0005 %
1 V	0.0018 % + 0.0006 %	0.0018 % + 0.0007 %	0.0025 % + 0.0007 %	0.0005 % + 0.0001 %
10 V	0.0013 % + 0.0004 %	0.0018 % + 0.0005 %	0.0024 % + 0.0005 %	0.0005 % + 0.0001 %
100 V	0.0018 % + 0.0006 %	0.0027 % + 0.0006 %	0.0038 % + 0.0006 %	0.0005 % + 0.0001 %
300 V	0.0018 % + 0.002 %	0.0031 % + 0.002 %	0.0041 % + 0.002 %	0.0005 % + 0.0003 %

Notes:

- For conducted disturbances on mains input >1 V from 10 MHz to 20 MHz, add 0.02 % of range. For disturbances >3 V, accuracy is unspecified.
- For radiated disturbances >1V/m from 450 MHz to 550 MHz, add 0.02 % of range. For disturbances > 3 V/m, accuracy is unspecified.

DC Voltage Additional Errors

Digits	NPLC	Ch. x01 – x20	Additional NPLC Noise Error
6 ½	200	add 2 µV	-
6 ½	100	add 2 µV	-
6 ½	10 (Slow)	add 2 µV	-
5 ½	1 (Medium)	add 2 µV	add 0.0008 % of range
4 ½	0.2 (Fast)	-	add 0.002 % of range + 12 µV
4 ½	0.02	-	add 0.014 % of range + 17 µV

AC Voltage

AC voltage specifications are for ac sine wave signals >5 % of range. For inputs from 1 % to 5 % of range and <50 kHz, add an additional error of 0.1 % of range. For 50 kHz to 100 kHz, add 0.13 % of range.

Maximum Input..... 300 V rms or 425 V peak or 3×10^7 volts-Hertz product (whichever is less) for any range.

Measurement Method..... AC-coupled true-rms. Measures the ac component of input with up to 300 V dc bias on any range.

AC Filter Bandwidth:

Slow..... 20 Hz
Fast..... 200 Hz

Maximum Crest Factor..... 5:1 at full scale

Additional Crest Factor Errors Crest factor 1-2, 0.05 % of full scale
Crest factor 2-3, 0.2 % of full scale
Crest factor 3-4, 0.4 % of full scale
Crest factor 4-5, 0.5 % of full scale

AC Voltage Input Characteristics

Range	Resolution	Resolution			Input Impedance
		4 ½ Digits	5 ½ Digits	6 ½ Digits	
100 mV	100.0000 mV	10 µV	1 µV	0.1 µV	1 MΩ ±2 % shunted by 150 pF
1 V	1.000000 V	100 µV	10 µV	1 µV	
10 V	10.00000 V	1 mV	100 µV	10 µV	
100 V	100.0000 V	10 mV	1 mV	100 µV	
300 V	300.000 V	100 mV	10 mV	1 mV	

AC Voltage Accuracy

Accuracy is given as ± (% measurement + % of range).

Range	Frequency	24 Hour (23 ±1 °C)	90 Days (23 ±5 °C)	1 Year (23 ±5 °C)	T.C./ °C Outside 18 °C to 28 °C
100 mV	20 Hz to 20 kHz	0.1 % + 0.05 %	0.11 % + 0.05 %	0.11 % + 0.05 %	0.01 % + 0.005 %
	20 kHz to 50 kHz	0.2 % + 0.05 %	0.22 % + 0.05 %	0.22 % + 0.05 %	0.01 % + 0.005 %
	50 kHz to 100 kHz	0.55 % + 0.08 %	0.6 % + 0.08 %	0.6 % + 0.08 %	0.05 % + 0.01 %
1 V	20 Hz to 20 kHz	0.1 % + 0.05 %	0.11 % + 0.05 %	0.11 % + 0.05 %	0.01 % + 0.005 %
	20 kHz to 50 kHz	0.2 % + 0.05 %	0.22 % + 0.05 %	0.22 % + 0.05 %	0.01 % + 0.005 %
	50 kHz to 100 kHz	0.55 % + 0.08 %	0.6 % + 0.08 %	0.6 % + 0.08 %	0.05 % + 0.01 %
10 V	20 Hz to 20 kHz	0.1 % + 0.05 %	0.11 % + 0.05 %	0.11 % + 0.05 %	0.01 % + 0.005 %
	20 kHz to 50 kHz	0.2 % + 0.05 %	0.22 % + 0.05 %	0.22 % + 0.05 %	0.01 % + 0.005 %
	50 kHz to 100 kHz	0.55 % + 0.08 %	0.6 % + 0.08 %	0.6 % + 0.08 %	0.05 % + 0.01 %
100 V	20 Hz to 20 kHz	0.1 % + 0.05 %	0.11 % + 0.05 %	0.11 % + 0.05 %	0.01 % + 0.005 %
	20 kHz to 50 kHz	0.2 % + 0.05 %	0.22 % + 0.05 %	0.22 % + 0.05 %	0.01 % + 0.005 %
	50 kHz to 100 kHz	0.55 % + 0.08 %	0.6 % + 0.08 %	0.6 % + 0.08 %	0.05 % + 0.01 %
300 V	20 Hz to 20 kHz	0.1 % + 0.05 %	0.11 % + 0.05 %	0.11 % + 0.05 %	0.01 % + 0.005 %
	20 kHz to 50 kHz	0.2 % + 0.05 %	0.22 % + 0.05 %	0.22 % + 0.05 %	0.01 % + 0.005 %
	50 kHz to 100 kHz	0.55 % + 0.27 %	0.6 % + 0.27 %	0.6 % + 0.27 %	0.05 % + 0.03 %

Note:
For conducted disturbances on mains input >1 V from 10 MHz to 40 MHz, add 0.02 % of range. For disturbances >3 V, accuracy is unspecified.

Additional Low Frequency Errors

Error is stated as % of reading.

Frequency	AC Filter	
	20 Hz	200 Hz
20 Hz to 40 Hz	0 %	-
40 Hz to 100 Hz	0 %	0.55 %
100 Hz to 200 Hz	0 %	0.2 %
200 Hz to 1 kHz	0 %	0.02 %
>1 kHz	0 %	0 %

DC Current

Input Protection 0.15 A / 600 V Resettable PTC

DC Current Input Characteristics

Range	Resolution	Resolution			Reference Resistance (Ohms)	Burden Voltage
		Fast 4½ Digits	Medium 5½ Digits	Slow 6½ Digits		
100 µA	100.0000 µA	10 nA	1 nA	0.1 nA	1k Ω	<1 mV
1 mA	1.000000 mA	100 nA	10 nA	1 nA	1k Ω	<1 mV
10 mA	10.00000 mA	1 µA	100 nA	10 nA	10 Ω	<1 mV
100 mA	100.0000 mA	10 µA	1 µA	100 nA	10 Ω	<1 mV

DC Current Accuracy

Accuracy is given as ± (% measurement + % of range).

Range	24 Hour (23 ±1 °C)	90 Days (23 ±5 °C)	1 Year (23 ±5 °C)	T.C./ °C Outside 18 °C to 28 °C
100 µA	0.005 % + 0.003 %	0.015 % + 0.0035 %	0.015 % + 0.0035 %	0.002 % + 0.001 %
1 mA	0.005 % + 0.001 %	0.015 % + 0.0011 %	0.015 % + 0.0011 %	0.002 % + 0.001 %
10 mA	0.005 % + 0.003 %	0.015 % + 0.0035 %	0.015 % + 0.0035 %	0.002 % + 0.001 %
100 mA	0.005 % + 0.001 %	0.015 % + 0.0035 %	0.015 % + 0.0035 %	0.002 % + 0.001 %

DC Current Additional Errors

Digits	NPLC	Additional NPLC Noise Error for 10 mA, 100 mA	Additional NPLC Noise Error for 100 µA, 1 mA
6½	200	-	-
6½	100	-	-
6½	10 (Slow)	-	-
5½	1 (Medium)	0.0008 % of range	0.0008 % of range
4½	0.2 (Fast)	0.002 % of range + 1.2 µA	0.002 % of range + 12 nA
4½	0.02	0.014 % of range + 1.7 µA	0.014 % of range + 17 nA

AC Current

Input Protection 0.15 A / 600 V resettable PTC

Measurement Method AC-coupled true-rms, dc-coupled to the shunt (no blocking capacitor).

AC Filter Bandwidth:

Slow 20 Hz

Fast 200 Hz

Maximum Crest Factor 5:1 at full scale

Additional Crest Factor Errors Crest factor 1-2, 0.05 % of full scale

Crest factor 2-3, 0.2 % of full scale

Crest factor 3-4, 0.4 % of full scale

Crest factor 4-5, 0.5 % of full scale

AC Current Input Characteristics

Range	Resolution	Resolution			Reference Resistance	Burden Voltage
		4½ Digits	5½ Digits	6½ Digits		
100 µA	100.0000 µA	10 nA	1 nA	0.1 nA	1 kΩ	<10 mV (RMS)
1 mA	1.000000 mA	100 nA	10 nA	1 nA	1 kΩ	<10 mV (RMS)
10 mA	10.00000 mA	1 µA	100 nA	10 nA	10 Ω	<20 mV (RMS)
100 mA	100.0000 mA	10 µA	1 µA	100 nA	10 Ω	<50 mV (RMS)

AC Current Accuracy

Accuracy is given as \pm (% measurement + % of range). Basic accuracy specification is for a sinusoidal signal with amplitude greater than 5 % of range. For input signals between 1 % to 5 % of range, add 0.1 % of range.

Range	Frequency	24 Hour (23 \pm 1 $^{\circ}$ C)	90 Days (23 \pm 5 $^{\circ}$ C)	1 Year (23 \pm 5 $^{\circ}$ C)	T.C./ $^{\circ}$ C Outside 18 $^{\circ}$ C to 28 $^{\circ}$ C
100 μ A	20 Hz to 2 kHz	0.2 % + 0.06 %	0.25 % + 0.06 %	0.3 % + 0.06 %	0.015 % + 0.005 %
1 mA	20 Hz to 2 kHz	0.2 % + 0.06 %	0.25 % + 0.06 %	0.3 % + 0.06 %	0.015 % + 0.005 %
10 mA	20 Hz to 2 kHz	0.2 % + 0.06 %	0.25 % + 0.06 %	0.3 % + 0.06 %	0.015 % + 0.005 %
100 mA	20 Hz to 2 kHz	0.2 % + 0.06 %	0.25 % + 0.06 %	0.3 % + 0.06 %	0.015 % + 0.005 %

Additional Low Frequency Errors

Error is stated as % of reading.

Frequency	AC Filter	
	20 Hz	200 Hz
20 Hz to 40 Hz	0 %	-
40 Hz to 100 Hz	0 %	0.55 %
100 Hz to 200 Hz	0 %	0.2 %
200 Hz to 1 kHz	0 %	0.02 %
>1 kHz	0 %	0 %

Frequency

Gate Times 100 milliseconds to 1 second.

Measurement Method Flexible counting technique. AC-coupled input using the ac voltage measurement function.

Settling Considerations When measuring frequency after a dc offset voltage change, errors may occur. For the most accurate measurement, wait up to 1 second for the input blocking capacitor to settle.

Measurement Considerations To minimize measurement errors, shield inputs from external noise when measuring low-voltage, low-frequency signals.

Frequency Accuracy

Accuracy is given as \pm % of measurement.

Range	Frequency	24 Hour (23 \pm 1 $^{\circ}$ C)	90 Days (23 \pm 5 $^{\circ}$ C)	1 Year (23 \pm 5 $^{\circ}$ C)	T.C./ $^{\circ}$ C Outside 18 $^{\circ}$ C to 28 $^{\circ}$ C
100 mV to 300 V ^[1] ^[2]	20 Hz to 40 Hz	0.03 %	0.03 %	0.03 %	0.001 %
	40 Hz to 1 MHz	0.006 %	0.01 %	0.01 %	0.001 %
[1] Input >100 mV. For 10 mV to 100 mV, multiply percent measurement error by 10. [2] Limited to 3×10^7 volt-Hertz					

Resistance

Measurement Method Current source referenced to LO input.

Max. Lead Resistance (4-wire ohms) 10 Ω per lead for 100 Ω , 1 k Ω ranges. 1 k Ω per lead on all other ranges.

Input Protection 300 V on all ranges.

Resistance Input Characteristics

Range	Resolution	Resolution			Source Current
		Fast 4½ Digits	Medium 5 ½ Digits	Slow 6 ½ Digits	
100 Ω	100.0000 Ω	10 mΩ	1 mΩ	0.1 mΩ	1 mA / 4 V
1 kΩ	1.000000 kΩ	100 mΩ	10 mΩ	1 mΩ	1 mA / 4 V
10 kΩ	10.000000 kΩ	1 Ω	100 mΩ	10 mΩ	100 µA / 6 V
100 kΩ	100.0000 kΩ	10 Ω	1 Ω	100 mΩ	100 µA / 12 V
1 MΩ	1.000000 MΩ	100 Ω	10 Ω	1 Ω	10 µA / 12 V
10 MΩ	10.000000 MΩ	1 kΩ	100 Ω	10 Ω	1 µA / 12 V
100 MΩ	100.0000 MΩ	10 kΩ	1 kΩ	100 Ω	0.1 µA / 12 V

Resistance Accuracy

Accuracy is given as ± (% measurement + % of range). Basic accuracy specification is for 4-wire resistance. For 2-wire resistance add 0.02 Ω internal resistance if using Channel 1 or 1.5 Ω if using channels x01 through x20, and add external lead wire resistance.

Range	24 Hour (23 ±1 °C)	90 Days (23 ±5 °C)	1 Year (23 ±5 °C)	T.C./ °C Outside 18 °C to 28 °C
100 Ω	0.003 % + 0.003 %	0.008 % + 0.004 %	0.01 % + 0.004 %	0.0006 % + 0.0005 %
1 kΩ	0.002 % + 0.0005 %	0.008 % + 0.001 %	0.01 % + 0.001 %	0.0006 % + 0.0001 %
10 kΩ	0.002 % + 0.0005 %	0.008 % + 0.001 %	0.01 % + 0.001 %	0.0006 % + 0.0001 %
100 kΩ	0.002 % + 0.0005 %	0.008 % + 0.001 %	0.01 % + 0.001 %	0.0006 % + 0.0001 %
1 MΩ	0.002 % + 0.001 %	0.008 % + 0.001 %	0.01 % + 0.001 %	0.001 % + 0.0002 %
10 MΩ	0.015 % + 0.001 %	0.02 % + 0.001 %	0.04 % + 0.001 %	0.003 % + 0.0004 %
100 MΩ	0.3 % + 0.01 %	0.8 % + 0.01 %	0.8 % + 0.01 %	0.05 % + 0.002 %

Note:

For conducted disturbances on mains input >1 V from 10 MHz to 40 MHz, add 0.6 % of range. For disturbances >3 V, accuracy is unspecified.

Resistance Additional Errors

Digits	NPLC	Additional NPLC Noise Error
6 ½	200	0 % of range
6 ½	100	0 % of range
6 ½	10 (Slow)	0 % of range
5 ½	1 (Medium)	0.0008 % of range
4 ½	0.2 (Fast)(only for 2-wire)	0.002 % of range + 12 mΩ
4 ½	0.02 (only for 2-wire)	0.01 % of range + 17 mΩ

RTD

Temperature Range-200 °C to 1200 °C (depending on the sensor)

Resistance Range 0 Ω to 4 kΩ

Maximum Lead Resistance (4-wire Ω) 2.5 % of range per lead for 400 Ω and 4 kΩ ranges

Sample Rate

Slow 10 PLC

Medium 2 PLC

Fast 1 PLC

RTD Temperature Accuracy

Accuracy is for 4-wire 100 Ω nominal RTD, using the slow sample rate. With 3-wire PRT/RTD add 0.015 °C if using Channel 1, or add 0.15 °C internal resistance mismatch to the accuracy specification if using channels x01 through x20, and add external lead wire resistance mismatch. When using medium or fast sample rate (NPLC <10), add the number given in the table to the accuracy specification. If the environment temperature is outside the specified range, multiply the Temperature Coefficient number by the temperature deviation and add to the accuracy specification. Linear interpolation may be used between points in the table. Specifications do not include sensor accuracy. The practical range of temperature measurement depends on the sensor and characterization.

Temperature	Accuracy	Medium/Fast Sample Rate (NPLC <10)	T.C./ °C Outside 18 °C to 28 °C
-200 °C	0.016 °C	add 0.02 °C	0.0026 °C
0 °C	0.038 °C	add 0.02 °C	0.0041 °C
300 °C	0.073 °C	add 0.03 °C	0.0063 °C
600 °C	0.113 °C	add 0.03 °C	0.0089 °C

Note:
For conducted disturbances on mains input >1 V from 10 MHz to 40 MHz, add 0.2 Celsius. For disturbances >3 V, accuracy is unspecified.

RTD Measurement Characteristics

Range	Temperature Display Resolution		Source Current
	Slow Sample Rate	Medium/Fast Sample Rate	
0 Ω to 400 Ω	0.001 °C	0.01 °C	1 mA
400 Ω to 4 kΩ	0.001 °C	0.01 °C	0.1 mA

Thermistor

Temperature Range -200 °C to 400 °C (depending on the sensor)

Resistance Range 0 Ω to 1 MΩ

Sample Rate

Slow 10 PLC
Medium 2 PLC
Fast 1 PLC

Thermistor Temperature Accuracy

Accuracy specifications are for a 4-wire thermistor using medium or slow sample rate. With 2-wire thermistor add the number given in the table to the accuracy specification for internal resistance. When using fast sample rate (NPLC <10), multiply the accuracy specification by 3. If the environment temperature is outside the specified range, increase the accuracy specification by 25 % for every 1 °C outside the specified environment temperature range. Specifications do not include sensor accuracy. The practical range of temperature measurement depends on the sensor.

Temperature	Accuracy			
	2.2 kΩ thermistor	5 kΩ thermistor	10 kΩ thermistor	2-wire
-40 °C	0.002 °C	0.007 °C	0.007 °C	add 0.002 °C
0 °C	0.005 °C	0.004 °C	0.003 °C	add 0.004 °C
25 °C	0.013 °C	0.007 °C	0.005 °C	add 0.016 °C
50 °C	0.019 °C	0.01 °C	0.011 °C	add 0.05 °C
100 °C	0.116 °C	0.054 °C	0.026 °C	add 0.34 °C
150 °C	0.527 °C	0.239 °C	0.1 °C	add 1.7 °C

Note:
For conducted disturbances on mains input >1 V from 10 MHz to 40 MHz, add 0.2 Celsius. For disturbances >3 V, accuracy is unspecified.

Thermistor Measurement Characteristics

Range	Temperature Display Resolution		Source Current
	Slow Sample Rate	Medium/Fast Sample Rate	
0 Ω to 98 kΩ	0.001 °C	0.01 °C	10 μA
95 kΩ to 1 MΩ	0.001 °C	0.01 °C	1 μA

Thermocouple

Temperature Range-270 °C to 2315 °C (depending on the sensor)

Voltage Range-15 mV to 100 mV

Sample Rate

Slow 10 PLC

Medium 2 PLC

Fast 1 PLC

Thermocouple Temperature Accuracy

Accuracy specifications apply using a slow sample rate. When using a medium or fast sample rate (NPLC < 10), increase the accuracy specification by 25 %. If the environment temperature is outside the specified range, increase the accuracy specification by 12 % for every 1 °C outside the specified environment temperature range. Accuracy with fixed/external CJC does not include the accuracy of the reference junction temperature. Linear interpolation may be used between points in the table. Specifications do not include sensor accuracy. The practical range of temperature measurement depends on the sensor.

Type (Range)	Temperature	Accuracy		
		Fixed / External CJC		Internal CJC
		Channel 1	Ch. x01 – x20	Ch. x01 – x20
K -270 °C to 1372 °C	-200 °C	0.28 °C	0.41 °C	1.60 °C
	0 °C	0.10 °C	0.15 °C	0.62 °C
	1000 °C	0.14 °C	0.20 °C	0.64 °C
T -270 °C to 400 °C	-200 °C	0.27 °C	0.40 °C	1.60 °C
	0 °C	0.10 °C	0.15 °C	0.65 °C
	200 °C	0.08 °C	0.12 °C	0.47 °C
R -50 °C to 1768 °C	0 °C	0.76 °C	1.13 °C	1.28 °C
	300 °C	0.42 °C	0.63 °C	0.71 °C
	1200 °C	0.33 °C	0.47 °C	0.52 °C
S -50 °C to 1768 °C	0 °C	0.74 °C	1.11 °C	1.26 °C
	300 °C	0.45 °C	0.67 °C	0.76 °C
	1200 °C	0.37 °C	0.54 °C	0.60 °C
J -210 °C to 1200 °C	0 °C	0.20 °C	0.29 °C	1.41 °C
	0 °C	0.08 °C	0.12 °C	0.61 °C
	1000 °C	0.11 °C	0.14 °C	0.53 °C
N -270 °C to 1300 °C	-200 °C	0.42 °C	0.62 °C	1.69 °C
	0 °C	0.15 °C	0.23 °C	0.64 °C
	500 °C	0.12 °C	0.17 °C	0.44 °C
E -270 °C to 1000 °C	0 °C	0.17 °C	0.25 °C	1.42 °C
	0 °C	0.07 °C	0.10 °C	0.61 °C
	300 °C	0.06 °C	0.09 °C	0.46 °C
	700 °C	0.08 °C	0.10 °C	0.45 °C

B 100 °C to 1820 °C	300 °C	1.32 °C	1.97 °C	1.97 °C
	600 °C	0.68 °C	1.02 °C	1.02 °C
	1200 °C	0.41 °C	0.60 °C	0.60 °C
	1600 °C	0.38 °C	0.55 °C	0.55 °C
C 0 °C to 2315 °C	600 °C	0.23 °C	0.33 °C	0.54 °C
	1200 °C	0.28 °C	0.40 °C	0.63 °C
	2000 °C	0.44 °C	0.60 °C	0.91 °C
D 0 °C to 2315 °C	600 °C	0.22 °C	0.32 °C	0.44 °C
	1200 °C	0.26 °C	0.36 °C	0.49 °C
	2000 °C	0.39 °C	0.53 °C	0.69 °C
G 0 °C to 2315 °C	600 °C	0.24 °C	0.36 °C	0.36 °C
	1200 °C	0.22 °C	0.32 °C	0.33 °C
	2000 °C	0.33 °C	0.46 °C	0.46 °C
L -200 °C to 900 °C	-200 °C	0.13 °C	0.19 °C	0.99 °C
	0 °C	0.08 °C	0.12 °C	0.62 °C
	800 °C	0.09 °C	0.12 °C	0.48 °C
M -50 °C to 1410 °C	0 °C	0.11 °C	0.16 °C	0.64 °C
	500 °C	0.10 °C	0.15 °C	0.51 °C
	1000 °C	0.10 °C	0.14 °C	0.41 °C
U -200 °C to 600 °C	-200 °C	0.25 °C	0.37 °C	1.48 °C
	0 °C	0.10 °C	0.15 °C	0.63 °C
	400 °C	0.08 °C	0.11 °C	0.40 °C
W 0 °C to 2315 °C	600 °C	0.24 °C	0.36 °C	0.36 °C
	1200 °C	0.22 °C	0.32 °C	0.33 °C
	2000 °C	0.33 °C	0.46 °C	0.46 °C

Thermocouple Measurement Characteristics

Range	Temperature Display Resolution	
	Slow Sample Rate	Medium/Fast Sample Rate
-270 °C to 2315 °C	0.01 °C	0.1 °C

Digital I/O

Absolute Voltage Range -4 V to 30 V
 Input Minimum Logic High 2.0 V
 Input Maximum Logic Low 0.7 V
 Output Type open drain active low
 Output Logic Low (<1 mA) 0 V to 0.7 V
 Maximum Sink Current 50 mA
 Output Resistance 47 Ω

Totalizer

Absolute Voltage Range -4 V to 30 V
 Minimum Logic High 2.0 V
 Maximum Logic Low 0.7 V
 Minimum Pulse Width 50 μs
 Maximum Frequency 10 kHz
 Debounce Time 1.7 ms
 Maximum Count 1048575 (20 bits)

Trigger

Absolute Voltage Range	-4 V to 30 V
Minimum Logic High	2.0 V
Maximum Logic Low	0.7 V
Minimum Pulse Width	50 μ s
Maximum Latency	100 ms

Alarm Output

Absolute Voltage Range	-4 V to 30 V
Output Type	open drain active low
Output Logic Low (<1 mA)	0 V to 0.7 V
Maximum Sink Current	50 mA
Output Resistance	47 Ω

2638A-100 Universal Input Module

General

Maximum Input	150 V CAT II on any range. 250V Max. (see safety notice in this manual under input protection)
Offset Voltage	<2 μ V
3-Wire Internal Resistance Mismatch	<50 m Ω
Basic CJC Accuracy	0.6 $^{\circ}$ C

General Maintenance

This section supplies information on how to clean the Product, reset the memory, and replace the fuse in the rear of the Product.

If the Product Does Not Turn On

To help solve problems encountered when turning on the Product:

1. Verify that the power switch is in the “On” position.
2. Make sure that the mains power cord is firmly plugged into the power module on the rear of the Product.
3. Make sure the power source that the Product is plugged into is energized.
4. Verify that the line power fuse is good. See “Replace the Line Power Fuse”.

If these steps do not solve the problem, then contact Fluke. See the “Contact Fluke”.

Clean the Product

To clean the Product, wipe the instrument with a cloth that is lightly dampened with water or mild detergent. Do not use aromatic hydrocarbons, chlorinated solvents, or methanol based fluids.

Caution

To prevent possible damage to the Product, do not use solvents or abrasive cleansers.

Caution

For safe operation and maintenance of the product:

- Have an approved technician repair the Product.
- Do not allow water to get inside the Product.

Replace the Line Power Fuse

The Product has a fuse that protects from overcurrent. Each voltage selection requires a specific fuse. See Table 2 for the correct fuse for each of the four line-voltage selections. This fuse is located on the rear panel.

Warning

To prevent possible electrical shock, fire, or personal injury, use only specified replacement parts.

Table 2. Fuses

Voltage Selector	Fuse	Fluke Part Number
100 V	0.25 A, 250 V (slow blow)	166306
120 V	0.25 A, 250 V (slow blow)	166306
220 V	0.160 A, 250 V (slow blow)	4394437
240 V	0.160 A, 250 V (slow blow)	4394437

To replace the fuses, see Figure :

1. Remove any high-capacity modules or test leads from the Product where hazardous voltage may be present.
2. Disconnect the mains-power cord from the power-entry module.
3. Insert a small, flat screwdriver blade into the narrow recess to the left of the fuse holder and pry to the right until the holder pops out. The Product is shipped with a replacement fuse of the same rating as the fuse installed in the fuse block.
4. Replace the fuse with the replacements as listed in Table 2.
5. Slide the fuse holder back into the Product until it locks into place.

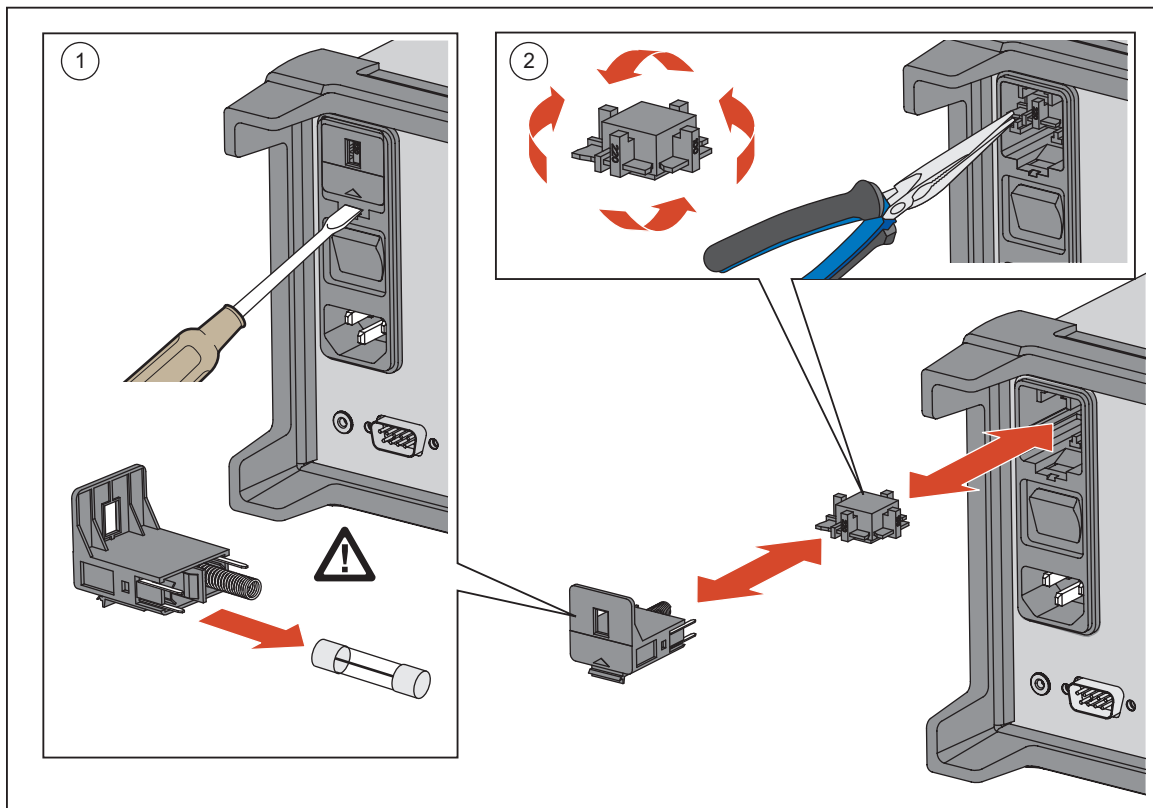

Figure 1. Fuse Replacement

hcn027.eps

Battery Replacement

The battery in the Product is used for Product memory (menu settings, readings, etc.).

To replace the battery:

1. Disassemble the Product as described in the *Disassembly* section.
2. Remove the battery (see Figure 9) and replace with one rated appropriately for the selected voltage button battery.
3. Reassemble the Product.

Memory and Factory Reset

The Product has two memory reset functions to remove data from the memory and reset the Product:

- Clear all Files
- Factory Reset

See Table 3 for a comparison of these functions.





Note

All memory reset functions require the Admin password.



Table 3. Memory Clear Functions

Task	Clear All Files	Factory Reset
Deletes Test Setup files, DMM Data files, and Scan Data files from the internal memory. ^[1]	•	
Clears the configuration of the Channel Setup, Test Setup, and Instrument Setup ^[2]		•
[1] Does not remove data from the USB drive.		
[2] Does not reset the MAC address, the serial number, calibration, clock time, or the Admin or User passwords.		

To clear all files:

1. Push .
2. Push  twice.
3. Enter the Admin password.
4. Push .
5. Push  to confirm.

To reset the Product to factory settings:

1. Push .
2. Push .
3. Enter the Admin password, then push .

Required Equipment

Table 4 lists the equipment required for performance tests and calibration adjustment of the Product.

Table 4. Required Test Equipment

Function	Instrument Type	Model	Comments
Volts DC	Standard	Fluke 5720A	
	8½ digit meter	Fluke 8508A	Used to characterized the 5522A
	4-wire short	Fluke low thermal 4-wire short or equivalent	Fluke PN 2653346
	Alternate standard ^[1]	Fluke 5522A	Must be characterized with 8508A
Volts ac	Standard	Fluke 5720A	
	8½ digit meter	Fluke 8508A	Used to characterized the 5522A
	4-wire short	Fluke low thermal 4-wire short or equivalent	Fluke PN 2653346
	Alternate standard ^[1]	Fluke 5522A	Must be characterized with 8508A
Frequency	Standard	Fluke 5522A	
	Alternate standard	Function generator	Specifications include 0.075 % frequency accuracy from 20 Hz to 40 Hz and 0.0025 % accuracy for frequencies up to 1 MHz
Ohms	Standard	Fluke 5720A	
	4-wire short	Fluke low thermal 4-wire short or equivalent	Fluke PN 2653346
	Alternate standard	The standard resistors which have equivalent spec with Fluke 5720A.	

Table 4. Required Test Equipment (cont.)

Function	Instrument Type	Model	Comments
PRT	Standard	Fluke 5522A (for 1 k Ω value) Standard resistors of 25 Ω , 100 Ω , 200 Ω , and 400 Ω	Resistance accuracy specification ($k = 2$) should be or better than: 40 ppm (for 25 Ω) 20 ppm (for 100 Ω , 200 Ω and 400 Ω)
	4-wire short	Fluke low thermal 4-wire short or equivalent	Fluke PN 2653346
	Alternate standard	The standard resistors which have equivalent specification.	
Thermistor	Standard	Fluke 5522A	Must be characterized with 8508A
	8½ digit meter	Fluke 8508A	Used to characterized the 5522A
	4-wire short	Fluke low thermal 4-wire short or equivalent	Fluke PN 2653346
	Alternate standard ^[1]	Fluke 5720A	
Current DC	Standard	Fluke 5522A	Must be characterized with 8508A
	8½ digit meter	Fluke 8508A	Used to characterized the 5522A
	Alternate standard ^[1]	Fluke 5720A	
Current ac	Standard	Fluke 5522A Fluke 5720A (for 10 μ A adjustment)	Fluke 5522A must be characterized with 8508A
	8½ digit meter	Fluke 8508A	Used to characterized the 5522A
	Alternate standard	Fluke 5720A	
2638A-100 Module	Metrology Drywell	Fluke 9171 with insert block	
	Reference thermistor probe	Fluke 5610-9	Accuracy 0.013 $^{\circ}$ C or better at 25 $^{\circ}$ C
	Reference thermometer	Fluke 1586A	Only for CJC verification
	E-type thermocouples	Omega TT-E-24-SLE	Must be calibrated. Accuracy 0.026 $^{\circ}$ C or better at 25 $^{\circ}$ C
Cables	To reduce the possibility of inducing errors with ac signals picked up by the test leads, use short, shielded twisted-pair PTFE-insulated test cables between the test equipment and the Meter. Fluke makes a 2 foot (PN 738716) and 4 foot (PN 738724) PTFE insulated test cable for this purpose		
[1] Other alternate standards beside those listed can be used as long as they provide sufficient traceable [Test uncertainty Ratios (TURs)] at each calibration and verification point.			

Test Considerations

For optimum performance, all test procedures should comply with these recommendations:

- Assure the calibration ambient temperature (T_{cal}) is stable and between 18 °C and 28 °C. Ideally, the calibration should be done at 23 °C \pm 2 °C.
- Assure ambient relative humidity is <80%.
- Allow a 60-minute warm-up period.
- Use shielded twisted-pair PTFE-insulated cables to reduce settling and noise errors.
- Keep all input cables as short as possible.
- Ensure that the calibration standards and test procedures used do not introduce additional errors.

Note

Ideally, the standards used to verify and adjust the Product should be four times more accurate than each full-scale error specification of the Product.

- Use the Fluke low-thermal 4-Wire short for all voltages and Ohm shorts. See Table 4 for Fluke part number.

Performance Tests

This section provides performance tests to verify that the Product operates within published specifications as well as a complete calibration procedure. The performance test and, if necessary, the calibration adjustment procedure can be done both periodically and after service or repair.

The performance tests can be used as an acceptance test upon receipt of the Product. Use the 90-day specifications when an acceptance test is done after the Product is calibrated.

These performance tests are provided to ensure that the Product is in proper operating condition. If the Product fails any of the performance tests, calibration adjustment and/or repair are needed. The performance test works best if done in the sequence shown in Table 5.

Each of the measurements listed in the following tests assumes the Product is being tested after a one-hour warm-up in an environment with an ambient temperature of 18 °C to 28 °C and a relative humidity of <80 %.

Note

All instrument settings for verification use power up conditions except as noted by the verification step.

Front Panel Test

To test the keypad and LEDs on the front panel:

1. Push Instrument Setup.
2. Push and hold **5** for 3 seconds to enter keypad diagnostic.
3. Push every key, the key name should be shown correctly on the screen.
4. Push **SCAN MONITOR**, **MEASURE DMM**, **CHANNEL SETUP**, **RECORD** and **0** again, to check the LED.
5. Push **F5** to exit the keypad diagnostic program.

DC Volts Verification

Connect the Product to the test equipment as shown in Figure 2 and apply the voltages listed in Table 5.

Note

For the 0 V tests, use the 4-wire short to short the Hi/Lo and Sense inputs.

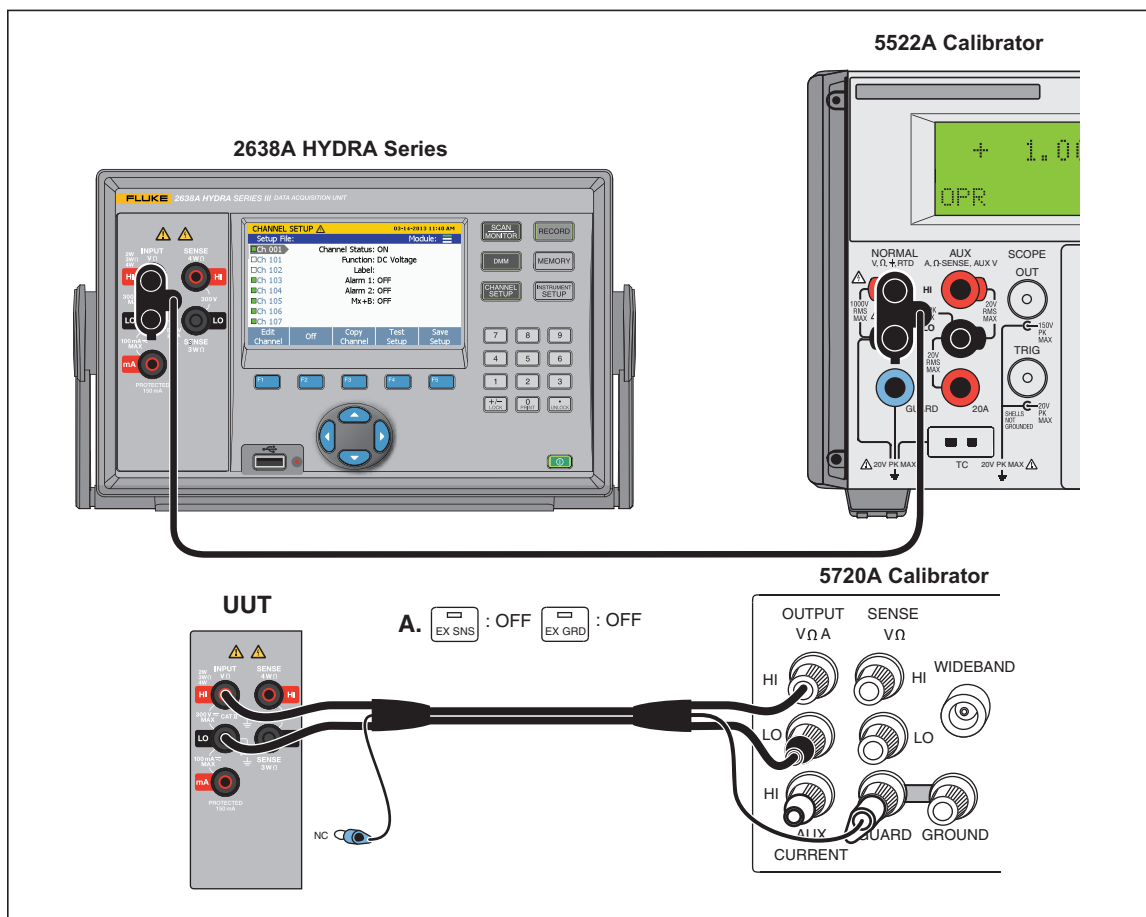

Figure 2. DC Voltage Test Connections

hcn105.eps

Table 5. DC Volts Verification Steps

Nominal Input(V)	Range	90-Day Test Limits		1-Year Test Limits	
		High	Low	High	Low
0	0.1	3.5 μ V	-3.5 μ V	3.5 μ V	-3.5 μ V
0.04 ^[1]	0.1	40.0045 mV	39.9955 mV	40.005 mV	39.995 mV
0.1 ^[1]	0.1	100.006 mV	99.994 mV	100.0072 mV	99.9928 mV
-0.04 ^[1]	0.1	-39.9955 mV	-40.0045 mV	-39.995 mV	-40.005 mV
-0.1 ^[1]	0.1	-99.994 mV	-100.006 mV	-99.9928 mV	-100.0072 mV
0	1	7.0 μ V	-7.0 μ V	7.0 μ V	-7.0 μ V
1 ^[1]	1	1.000025 V	0.999975 V	1.000032 V	0.999968 V
-1 ^[1]	1	-0.999975 V	-1.000025 V	-0.999968 V	-1.000032 V
0	10	50.0 μ V	-50.0 μ V	50.0 μ V	-50.0 μ V
10 ^[1]	10	10.00023 V	9.99977 V	10.00029 V	9.99971 V
-10 ^[1]	10	-9.99977 V	-10.00023 V	-9.99971 V	-10.00029 V
0	100	600.0 μ V	-600.0 μ V	600.0 μ V	-600.0 μ V
100 ^[1]	100	100.0033 V	99.9967 V	100.0044 V	99.9956 V
-100 ^[1]	100	-99.9967 V	-100.0033 V	-99.9956 V	-100.0044 V
0	300	6.0 mV	-6.0 mV	6.0 mV	-6.0 mV
300 ^[1]	300	300.0153 V	299.9847 V	300.0183 V	299.9817 V
-300 ^[1]	300	-299.9847 V	-300.0153 V	-299.9817 V	-300.0183 V

[1] 5522A must be used with 8508A to obtain suitable test uncertainty ratio.

Volts AC and Frequency Verification

Connect the Product to the test equipment as shown in Figure 3 and apply the voltages listed in Table 6 and Table 7.

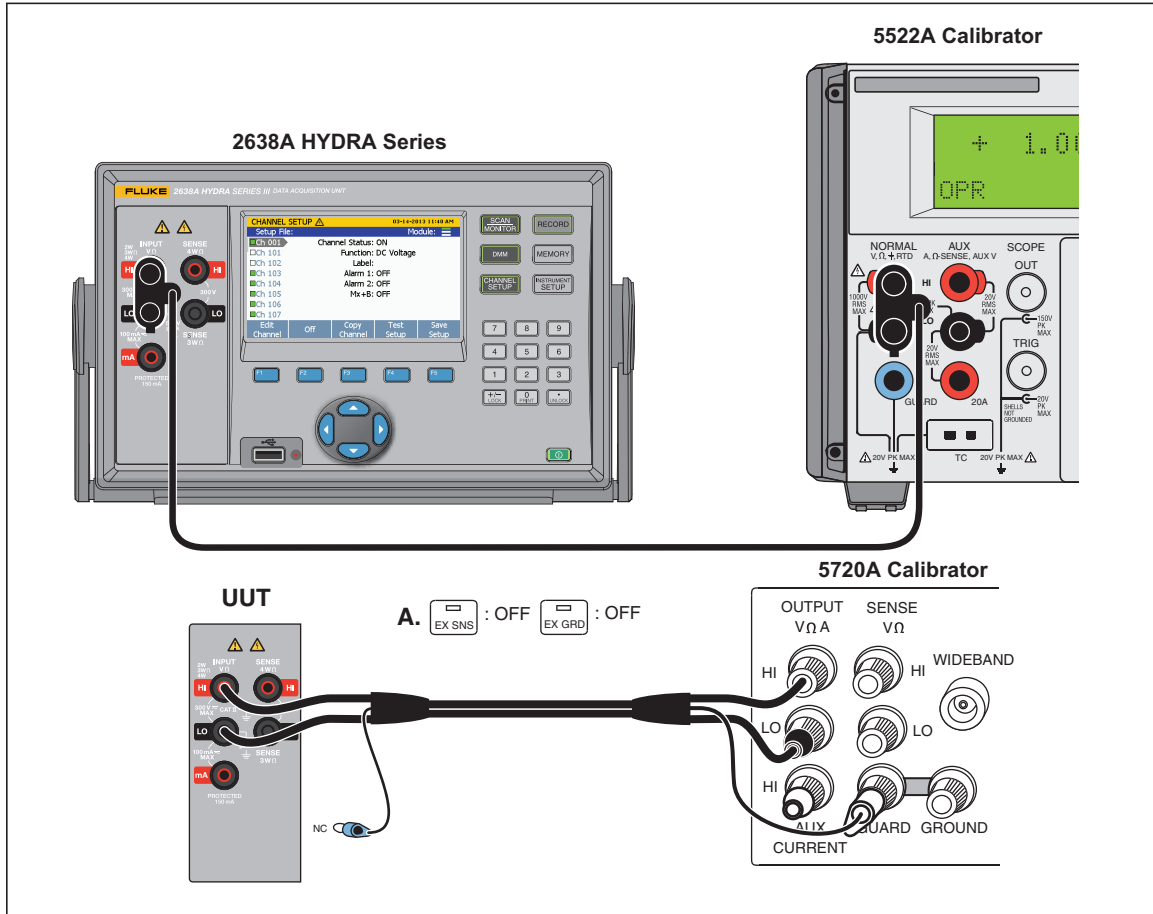

Figure 3. AC Volts Verification Connections

hcn105.eps

Table 6. AC Volts Verification Steps

Nominal Input		Range	90-Day Test Limits		1-Year Test Limits	
Ampl.	Freq.		High	Low	High	Low
100.0 mV	20 Hz	0.1	100.16 mV	99.84 mV	100.16 mV	99.84 mV
100.0 mV	20 kHz	0.1	100.16 mV	99.84 mV	100.16 mV	99.84 mV
100.0 mV	50 kHz	0.1	100.27 mV	99.73 mV	100.27 mV	99.73 mV
100.0 mV	100 kHz	0.1	100.68 mV	99.32 mV	100.68 mV	99.32 mV
1 V	20 Hz	1	1.0016 V	0.9984 V	1.0016 V	0.9984 V
1 V	20 kHz	1	1.0016 V	0.9984 V	1.0016 V	0.9984 V
1 V	50 kHz	1	1.0027 V	0.9973 V	1.0027 V	0.9973 V
1 V	100 kHz	1	1.0068 V	0.9932 V	1.0068 V	0.9932 V
10 V	20 Hz	10	10.016 V	9.984 V	10.016 V	9.984 V
10 V	20 kHz	10	10.016 V	9.984 V	10.016 V	9.984 V
10 V	50 kHz	10	10.027 V	9.973 V	10.027 V	9.973 V
10 V	100 kHz	10	10.068 V	9.932 V	10.068 V	9.973 V
30 V	20 Hz	100	30.083 V	29.917 V	30.083 V	29.917 V
100 V	20 kHz	100	100.16 V	99.84 V	100.16 V	99.84 V
100 V	50 kHz	100	100.27 V	99.73 V	100.27 V	99.73 V
100 V ^[1]	100 kHz	100	100.68 V	99.32 V	100.68 V	99.32 V
30 V	20 Hz	300	30.183 V	29.817 V	30.183 V	29.817 V
300 V	20 kHz	300	300.48 V	299.52 V	300.48 V	299.52 V
300 V	50 kHz	300	300.81 V	299.19 V	300.81 V	299.19 V
300 V	100 kHz	300	302.61 V	297.39 V	302.61 V	297.39 V

[1] 5522A must be used with 8508A to obtain suitable test uncertainty ratio.

Table 7. AC Volts Frequency Verification Steps

Nominal Input		90-day Test Limits		1-year Test Limits	
Ampl.	Frequency	High	Low	High	Low
1 V	20 Hz	20.006 Hz	19.994 Hz	20.006 Hz	19.994 Hz
1 V	40 Hz	40.012 Hz	39.988 Hz	40.012 Hz	39.988 Hz
100 mV	300 kHz	300.03 kHz	299.97 kHz	300.03 kHz	299.97 kHz
100 mV	1 MHz	1.0001 MHz	999.9 kHz	1.0001 MHz	999.9 kHz

4-Wire Ohms Verification

Connect the Product to the test equipment as shown in Figure 4 and apply the resistance listed in Table 8.

Note

For the 0 Ω tests, use the 4-wire short to short the Hi/Lo and Sense inputs.

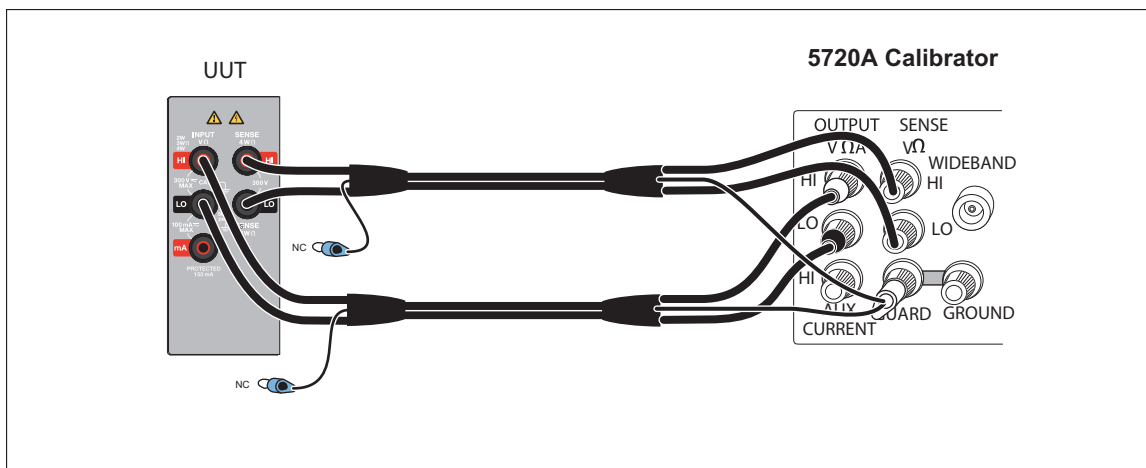

Figure 4. 4-Wire Ohms Test Equipment Setup

hcn305.eps

Table 8. 4-Wire Ohms Verification Steps

Nominal Input	Range	90-Day Test Limits		1-Year Test Limits	
		High	Low	High	Low
0 Ω	100	0.004 Ω	-0.004 Ω	0.004 Ω	-0.004 Ω
100 Ω	100	100.012 Ω	99.988 Ω	100.014 Ω	99.986 Ω
0 Ω	1 k	0.00001 kΩ	-0.00001 kΩ	0.00001 kΩ	-0.00001 kΩ
1 k Ω	1 k	1.00009 kΩ	0.99991 kΩ	1.00011 kΩ	0.99989 kΩ
0 Ω	10 k	0.0001 kΩ	-0.0001 kΩ	0.0001 kΩ	-0.0001 kΩ
10 k Ω	10 k	10.0009 kΩ	9.9991 kΩ	10.0011 kΩ	9.9989 kΩ
0 Ω	100 k	0.001 kΩ	-0.001 kΩ	0.001 kΩ	-0.001 kΩ
100 k Ω	100 k	100.009 kΩ	99.991 kΩ	100.011 kΩ	99.989 kΩ
0 Ω	1 M	0.00001 MΩ	-0.00001 MΩ	0.00001 MΩ	-0.00001 MΩ
1 M Ω	1 M	1.00009 MΩ	0.99991 MΩ	1.00011 MΩ	0.99989 MΩ
0 Ω	10 M	0.0001 MΩ	-0.0001 MΩ	0.0001 MΩ	-0.0001 MΩ
10 M Ω	10 M	10.0021 MΩ	9.9979 MΩ	10.0041 kΩ	9.9959 MΩ
0 Ω ^[1]	100 M	0.01 MΩ	-0.01 MΩ	0.01 MΩ	-0.01 MΩ
100 M Ω ^[1]	100 M	100.81 MΩ	99.19 MΩ	100.81 MΩ	99.19 MΩ
[1] 2-Wire					

PRT Verification Steps

Connect the Product as in Figure 5 for the 1 k Ω value listed in Table 9. For all other values in the table, use standard resistors. Configure the Ch001 as 4-wire PRT function with resistance display.

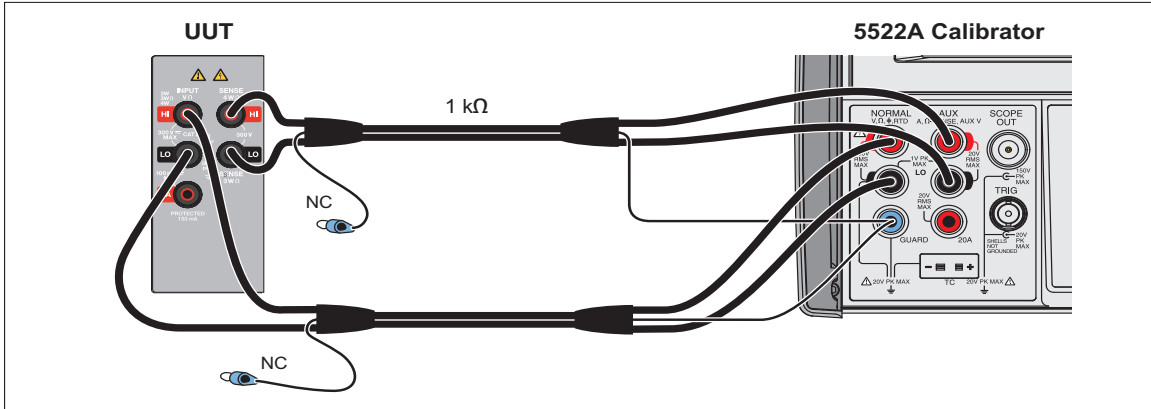

Figure 5. PRT Verification Connection

hcn312.eps

Configure Resistance Display

After configuring the channel Ch001 to 4-wire PRT function, send the following command through the remote interface to configure the resistance display:

TEMP:FPRT:CALC:RES ON, (@1)

Table 9. PRT Verification Steps

Nominal Input	Range	1-Year Test Limits	
		High	Low
0 Ω	100	0.005 Ω	-0.005 Ω
25 Ω	100	25.0075 Ω	24.9925 Ω
100 Ω	100	100.015 Ω	99.985 Ω
1k Ω	1 k	1.0002 k Ω	0.9998 k Ω

Thermistor Verification Steps

Connect the Product to the test equipment as shown in Figure 6 and apply the resistance listed in Table 10. Configure Ch001 as a 4-wire thermistor function with resistance display.

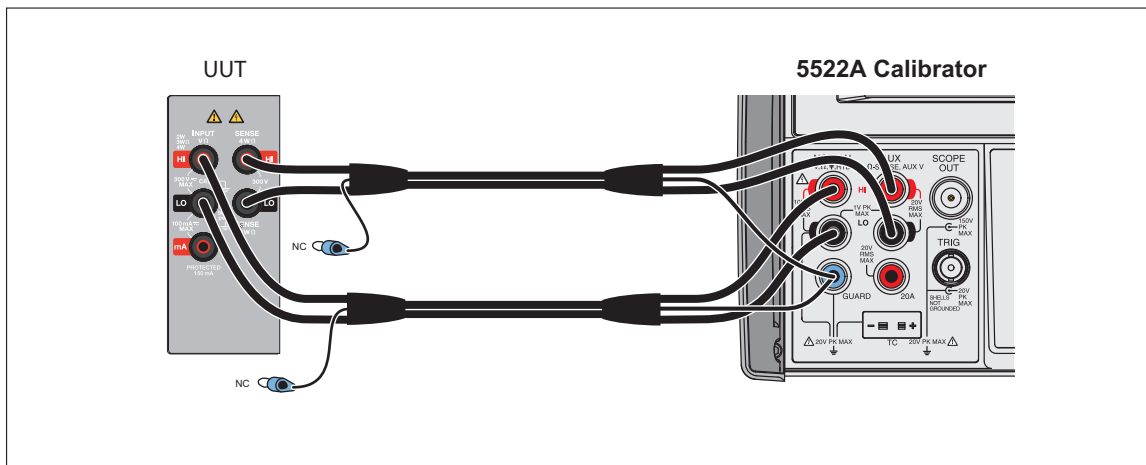

Figure 6. Thermistor Test Equipment Setup

hcn304.eps

Configure Resistance Display

After configuring the channel Ch001 to 4-wire thermistor function, send this command through the remote interface to configure the resistance display. Apply the values in Table 10:

TEMP:FTH:CALC:RES ON, (@1)

Table 10. Thermistor Verification Steps

Nominal Input	Range	1-Year Test Limits	
		High	Low
0 Ω	2.2 k	0.5 Ω	-0.5 Ω
2 k Ω	2.2 k	2000.7 Ω	1999.3 Ω
90 k Ω	98 k	90010 Ω	89990 Ω
900 k Ω	1 M	900370 Ω	899630 Ω

DC Current Verification

Connect the Product to the test equipment as shown in Figure 7 and apply the resistance listed in Table 11.

Note

When the 5720A/5522A is used as source, connect Hi (source) to Lo (Product) and Lo (source) to mA (Product). For the 0 A tests, open Lo inputs.

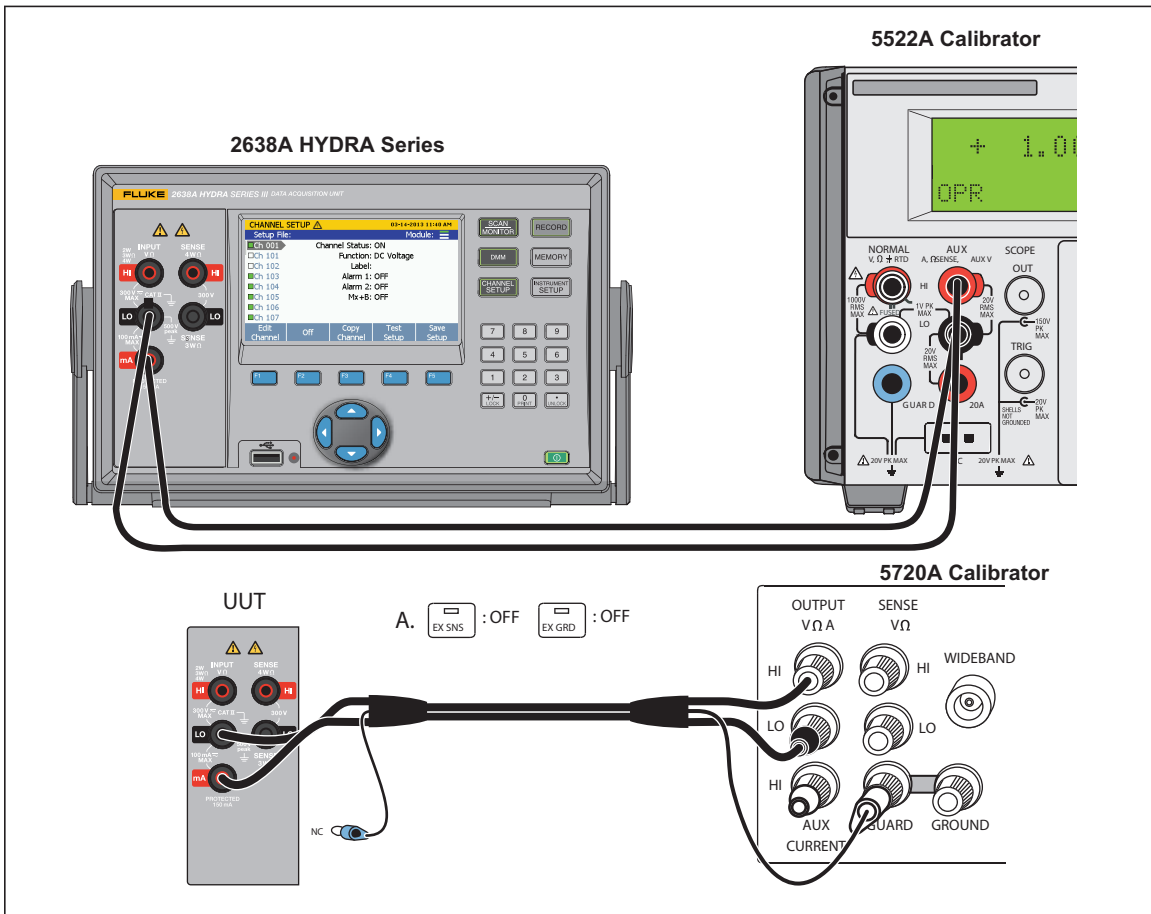

Figure 7. mA DC Current Equipment Setup

hcn308.eps

Table 11. DC Current Verification Steps

Nominal Input (mA)	Range	90-Day Test Limits		1-Year Test Limits	
		High	Low	High	Low
0	0.1	3.5 nA	-3.5 nA	3.5 nA	-3.5 nA
0.1 ^[1]	0.1	100.0185 μ A	99.9815 μ A	100.0185 μ A	99.9815 μ A
-0.1 ^[1]	0.1	-99.9815 μ A	-100.0185 μ A	-99.9815 μ A	-100.0185 μ A
0	1	11.0 nA	-11.0 nA	11.0 nA	-11.0 nA
1 ^[1]	1	1.000161 mA	0.999839 mA	1.000161 mA	0.999839 mA
-1 ^[1]	1	-0.999839 mA	-1.000161 mA	-0.999839 mA	-1.000161 mA
0	10	0.35 μ A	-0.35 μ A	0.35 μ A	-0.35 μ A
10 ^[1]	10	10.00185 mA	9.99815 mA	10.00185 mA	9.99815 mA
-10 ^[1]	10	-9.99815 mA	-10.00185 mA	-9.99815 mA	-10.00185 mA
0	100	3.5 μ A	-3.5 μ A	3.5 μ A	-3.5 μ A
100 ^[1]	100	100.0185 mA	99.9815 mA	100.0185 mA	99.9815 mA
-100 ^[1]	100	-99.9815 mA	-100.0185 mA	-99.9815 mA	-100.0185 mA

[1] 5720A or 5522A must be used with 8508A to obtain suitable test uncertainty ratio.

AC Current Verification Steps

Connect the Meter to the test equipment as shown in Figure 8 and, depending on which meter you are calibrating, apply the resistance listed in Table 12.

Note

When use 5720A/5522A as source, connect Hi (source) to Lo (meter) and Lo (source) to mA (meter). For the zero (0) A tests, open Lo inputs.

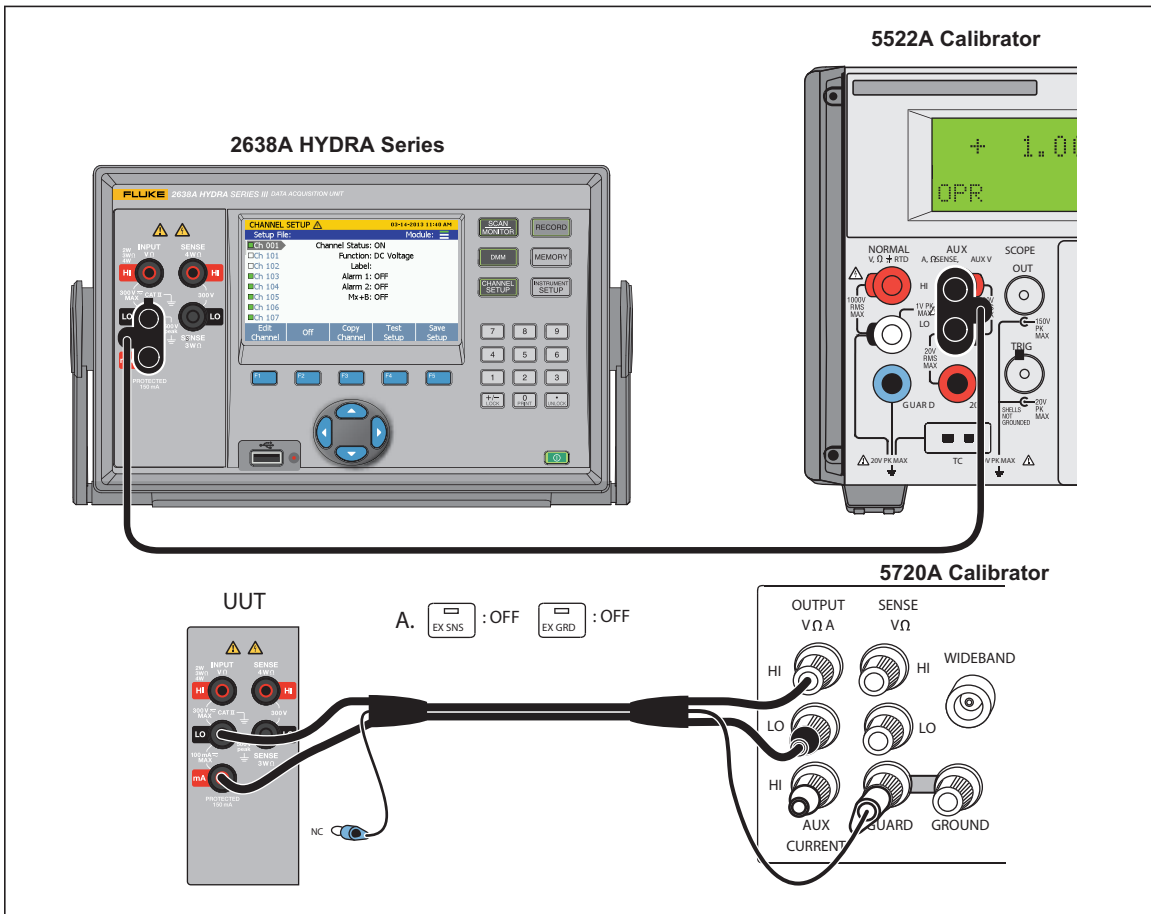

Figure 8. mA AC Current Equipment Setup

hcn311.eps

Table 12. AC Current Verification Steps

Nominal Input		Range	90-day Test Limits		1-year Test Limits	
Ampl.	Frequency		High	Low	High	Low
100.0 $\mu\text{A}^{[1]}$	20 Hz	0.1	100.31 μA	99.69 μA	100.36 μA	99.64 μA
100.0 $\mu\text{A}^{[1]}$	2 kHz	0.1	100.31 μA	99.69 μA	100.36 μA	99.64 μA
1.0 $\text{mA}^{[1]}$	20 Hz	1	1.0031 mA	0.9969 mA	1.0036 mA	0.9964 mA
1.0 $\text{mA}^{[1]}$	2 kHz	1	1.0031 mA	0.9969 mA	1.0036 mA	0.9964 mA
10.0 $\text{mA}^{[1]}$	20 Hz	10	10.031 mA	9.969 mA	10.036 mA	9.964 mA
10.0 $\text{mA}^{[1]}$	2 kHz	10	10.031 mA	9.969 mA	10.036 mA	9.964 mA
100.0 $\text{mA}^{[1]}$	20 Hz	100	100.31 mA	99.69 mA	100.36 mA	99.64 mA
100.0 $\text{mA}^{[1]}$	2 kHz	100	100.31 mA	99.69 mA	100.36 mA	99.64 mA

[1] 5522A must be used with 8508A to obtain suitable test uncertainty ratio.

2638A-100 Module Verification

1. Connect the calibrated E-type thermocouples to channel 10 on the Product (UUT).
2. Insert the thermocouples into a drywell calibrator which is set and stabilized at 25 °C.
3. Configure the channels of the Product (UUT) for an E-thermocouple.
4. Insert the reference thermistor probe into the drywell to measure the actual temperature.
5. Use the reference thermometer with the reference thermistor probe and the thermocouples on the Product (UUT) to measure the drywell temperature until all readings are stable.
6. Compare the thermocouple readings and reference thermometer reading. The difference should be <0.6 °C.

Calibration Adjustment

Calibration adjustment should be done at the desired interval, or whenever a verification test indicates that a Product function is out of tolerance. Product accuracy stays within specifications only if the adjustment procedure is done at regular intervals. A one-year interval is adequate for most applications. Product accuracy specifications are not valid beyond the one-year interval.

Adjustments are accessed through both the remote interface and front panel with a series of adjustment steps. The remote program directs the test equipment to apply a series of shorts, opens, voltages, currents, and resistances to the Product. At each step, the Product internally makes the necessary adjustment to bring the Product into specification. No internal mechanical adjustments are necessary.

With an automated, computer-controlled procedure, the calibration and verification procedures can be done in under an hour. A simple adjustment program is listed in the *Sample Adjustment Program* section. A MetCal program is available at www.fluke.com to adjust the Product.

Adjustments are password protected to prevent accidental or unauthorized adjustments. The admin password must be entered through the front panel or remote interface.

Unlock the Product

To unlock the Product for adjustments from the front panel:

1. Push **Instrument Setup**.
2. Push **Calibrate**.
3. Use the numeric keypad to enter the 4-digit admin password.
4. Push **OK** to enter the password and continue the adjustments procedure.

The Product is shipped from the factory with the password set to **2638**.

Unlock the Product with a Remote Interface

To unlock the Product with a remote interface, send the command:

```
CAL:SEC:STAT OFF,"2638"
```

To relock the Product, send the command:

```
CAL:SEC:STAT ON
```

Reset the Admin Password

If the admin password is lost or forgotten, the password can be reset to 2638 with these steps:

Note

*Before doing these steps, try to use the factory default password:
2638.*

1. Do the general disassembly steps in the “Disassembly” section.
2. Connect a jumper across J8, as shown in Figure 9.
3. Reconnect the mains power cable between the Product and a power outlet.
4. Turn the Product on.
5. When the Product is started, the password will automatically be reset to **2638.**
6. Turn the Product off and disconnect the mains power cable.
7. Remove the jumper connected in step 2.
8. Reassemble the Product by doing the reverse procedure in “Disassembly”.

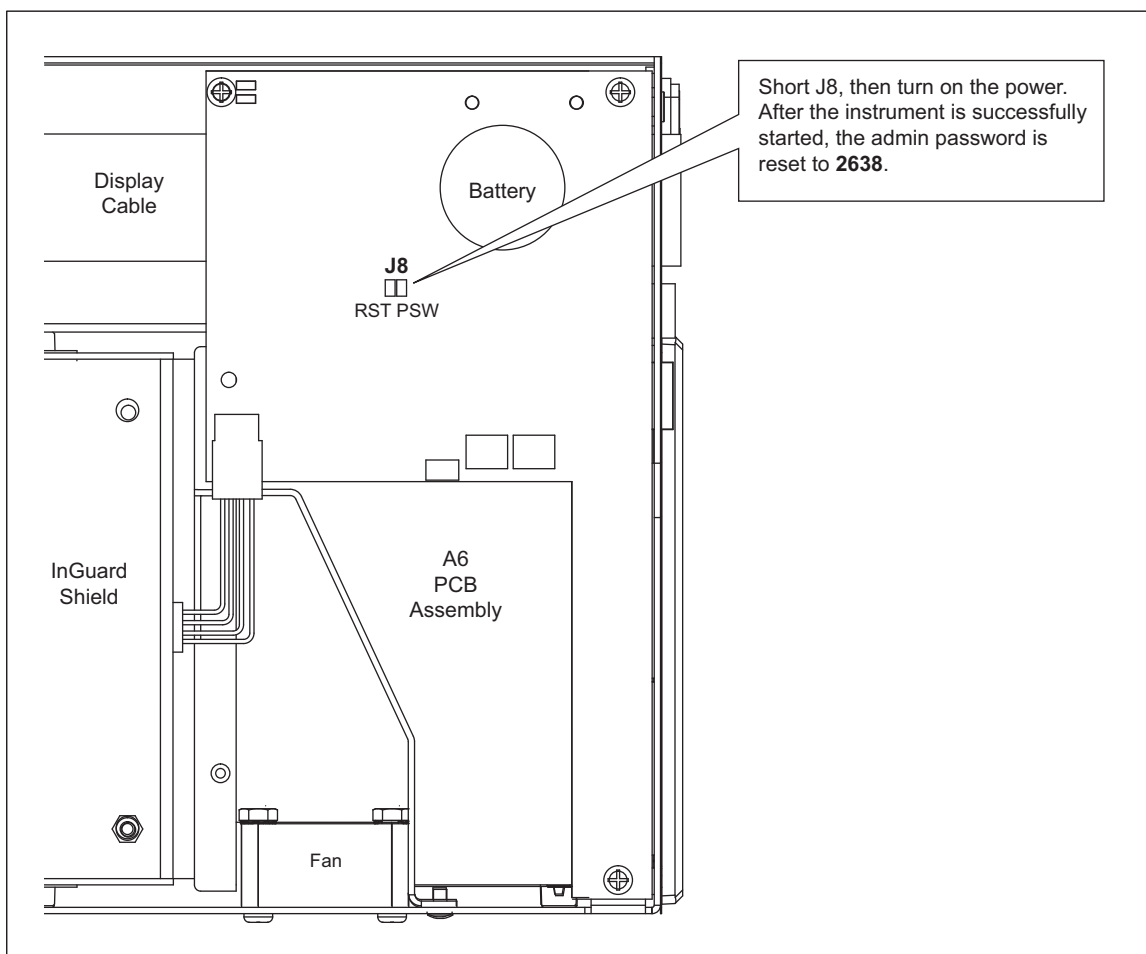

Figure 9. Password Reset Jumper

hcn103.eps

Disassembly

⚠⚠ Warning

To prevent possible electrical shock or personal injury, disconnect the mains power cord before you remove the Product covers.

Only disassemble the Product to reset the password or replace the battery. See Figure 10.

A 2# Phillips screwdriver and small crescent wrench are required to disassemble the Product.

1. Remove all high-capacity modules and test leads from the Product.
2. Turn off the mains power at the rear of the Product and remove the mains power cord. The front panel power key only puts the Product into a power-save mode and does not remove mains power.
3. Remove the bumpers by pulling from a corner and stretching the bumpers off the Product.
4. Remove the bail by rotating the handle upright to a 90 ° angle from the top of the Product and pull the bail out from the sides.
5. Remove the top cover by removing the two screws on the sides of the chassis, and slide the cover towards the back of the Product.

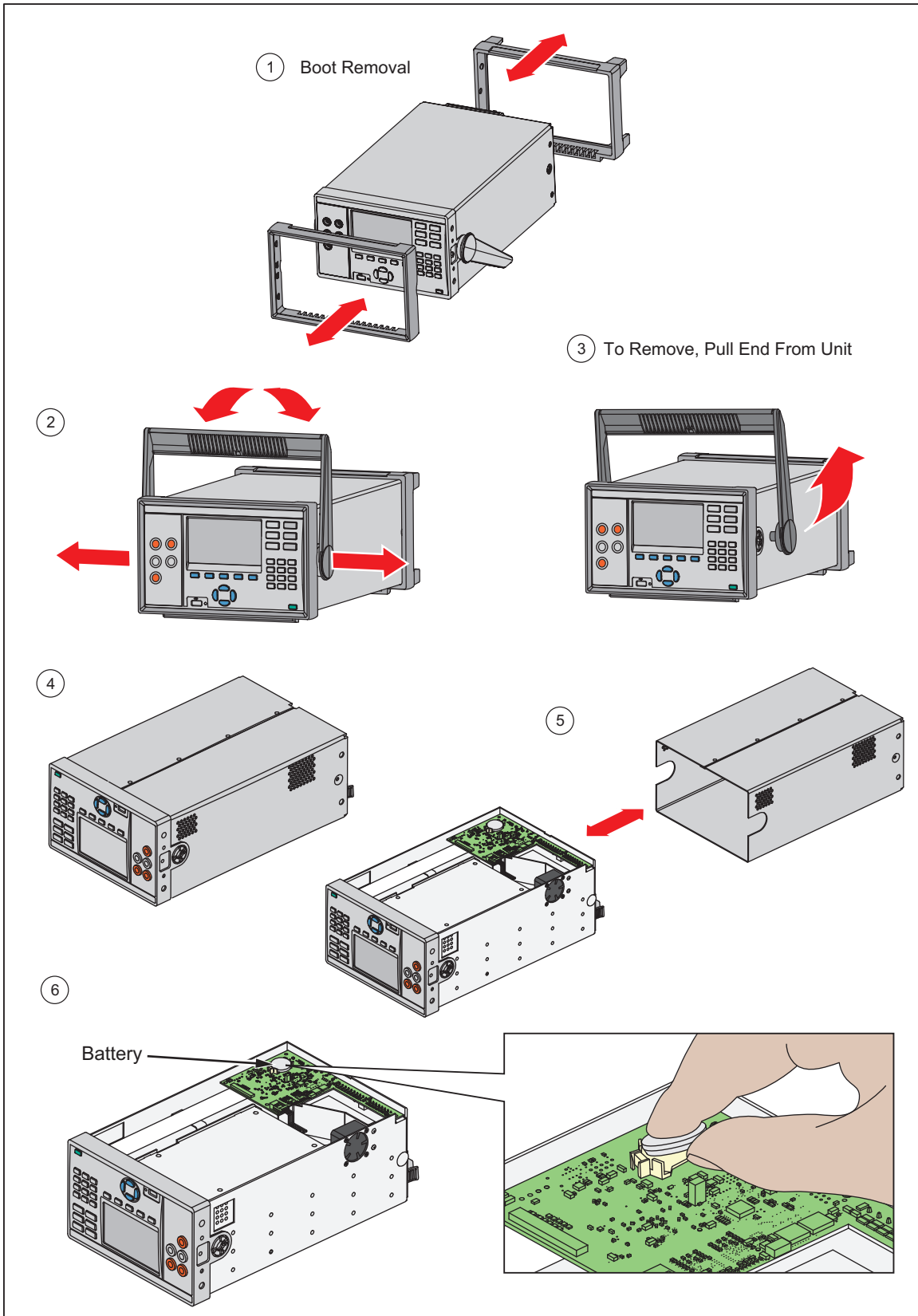

Figure 10. Disassembly

Change the Calibration Date Remotely

The calibration date is automatically updated when the “CALibrate:STORe” command is sent.

“Mainframe” Adjustment Process

Table 13 lists:

- Step numbers
- Description of the adjustment
- Measurement adjustment type (open, zero, or gain adjustment)
- Product value or range that is to be adjusted
- Amplitude of the adjustment signal
- The frequency of the adjustment signal (if necessary)

Table 13. Adjustment Steps

Step	Value Range	Input Signal	Description	Entry Point
MAIN				
A2D		open	ADC self-calibration	Y
ACV				
AC100MV	0.1		Start calibration of ac 100 mV range	Y
AC_100MV_1		100.0 mV, 1 kHz		N
AC_50MV_1		50.0 mV, 1 kHz		N
AC_25MV_1		25.0 mV, 1 kHz		N
AC_5MV_1		5.0 mV, 1 kHz		N
AC_0V_1		0.0 V		N
AC1V	1.0		Start calibration of ac 1 V range	Y
AC_1V_2		1.0 V, 1 kHz		N
AC_0_5V_2		0.5 V, 1 kHz		N
AC_0_25V_2		0.25 V, 1 kHz		N
AC_0_05V_2		0.05 V, 1 kHz		N
AC_0V_2		0.0 V		N
AC_1V_LF		1 V, 20 Hz	AC LF compensation	N
AC10V	10.0		Start calibration of ac 10 V range	Y
AC_10V_3		1.0 V, 1 kHz		N
AC_5V_3		5.0 V, 1 kHz		N

Table 13. Adjustment Steps (cont.)

Step	Value Range	Input Signal	Description	Entry Point
AC_2_5V_3		2.5 V, 1 kHz		N
AC_0_5V_3		0.5 V, 1 kHz		N
AC_0V_3		0.0 V		N
AC100V	100.0		Start calibration of ac 100 V range	Y
AC_100V_4		100.0 V, 1 kHz		N
AC_50V_4		50.0 V, 1 kHz		N
AC_25V_4		25.0 V, 1 kHz		N
AC_5V_4		5.0 V, 1 kHz		N
AC_0V_4		0.0 V		N
AC300V	300.0		Start calibration of ac 300 V range	Y
AC_300V_5		300.0 V, 1 kHz		N
AC_200V_5		200.0 V, 1 kHz		N
AC_100V_5		100.0 V, 1 kHz		N
AC_50V_5		50.0 V, 1 kHz		N
AC_0V_5		0.0 V		N
DCV				
DC100MV	0.1		Start calibration of dc 100 mV range	Y
DC_P100MV_1		100.0 mV		N
DC_0V_1		0.0 V		N
DC_N100MV_1		-100.0 mV		N
DC1V	1.0		Start calibration of dc 1 V range	Y
DC_P1V_2		1.0 V		N
DC_0V_2		0.0 V		N
DC_N1V_2		-1.0 V		N
DC10V	10.0		Start calibration of dc 10 V range	Y
DC_P10V_3		10.0 V		N
DC_0V_3		0.0 V		N

Table 13. Adjustment Steps (cont.)

Step	Value Range	Input Signal	Description	Entry Point
DC_N10V_3		-10.0 V		N
DC100V	100.0		Start calibration of dc 100 V range	Y
DC_P100V_4		100.0 V		N
DC_0V_4		0.0 V		N
DC_N100V_4		-100.0 V		N
DC300V	300.0		Start calibration of dc 300 V range	Y
DC_P300V_5		300.0 V		N
DC_0V_5		0.0 V		N
DC_N300V_5		-300.0 V		N
OHM				
R100	100.0		Start calibration of FRES 100 Ω range	Y
R_100_1		100.0 Ω		N
R_19_1		19.0 Ω		N
R_0_1		0.0 Ω		N
R1K	1.0E+3		Start calibration of FRES 1 k Ω range	Y
R_1K_2		1.0 k Ω		N
R_190_2		190.0 Ω		N
R_0_2		0.0 Ω		N
R10K	10.0E+3		Start calibration of FRES 10 k Ω range	Y
R_10K_3		10.0 k Ω		N
R_1_9K_3		1.9 k Ω		N
R_0_3		0.0 Ω		N
R100K	100.0E+3		Start calibration of FRES 100 k Ω range	Y
R_100K_4		100.0 k Ω		N
R_19K_4		19.0 k Ω		N

Table 13. Adjustment Steps (cont.)

Step	Value Range	Input Signal	Description	Entry Point
R_0_4		0.0 Ω		N
R1M	1.0E+6		Start calibration of FRES 1 M Ω range	Y
R_1M_5		1.0 M Ω		N
R_190K_5		190.0 k Ω		N
R_100K_5		100.0 k Ω		N
R_0_5		0.0 Ω		N
R10M	10.0E+6		Start calibration of RES 10 M Ω range	Y
R_10M_6		10.0 M Ω		N
R_1_9M_6		1.9 M Ω		N
R_1_0M_6		1.0 M Ω		N
R_0_6		0.0 Ω		N
R100M	100.0E+6		Start calibration of RES 100 M Ω range	Y
R_100M_7		100.0 M Ω		N
R_19M_7		19.0 M Ω		N
R_0_7		0.0 Ω		N
THERM				
T2K	2.2E+3		Start calibration of FTH 2 k Ω range	Y
T_1_9K_1		1.9 k Ω		N
T_1_0K_1		1.0 k Ω		N
T_190_1		190.0 Ω		N
T_0_1		0.0 Ω		N
T90K	90.0E+3		Start calibration of FTH 90 k Ω range	Y
T_100K_2		100.0 k Ω		N
T_19K_2		19.0 k Ω		N
T_10K_2		10.0 k Ω		N
T_0_2		0.0 Ω		N
T1M	90.0E+3		Start calibration of FTH 1 M Ω range	Y

Table 13. Adjustment Steps (cont.)

Step	Value Range	Input Signal	Description	Entry Point
T_1M_3		1.0 MΩ		N
T_190K_3		190.0 kΩ		N
T_100K_3		100.0 kΩ		N
T_0_3		0.0 Ω		N
HZ				
HZ1K			Start calibration of frequency	Y
HERTZ		1000.0 Hz, 1 V		N
ACI				
AC100UA	100.0E-6		Start calibration of ac 100 μA range	Y
AC_100UA_1		100.0 μA, 500 Hz		N
AC_50UA_1		50.0 μA, 500 Hz		N
AC_25UA_1		25.0 μA, 500 Hz		N
AC_10UA_1		10.0 μA, 500 Hz		N
AC_0A_1		Open		N
AC1MA	1.0E-3		Start calibration of ac 1 mA range	Y
AC_1MA_2		1.0 mA, 500 Hz		N
AC_0_5MA_2		0.5 mA, 500 Hz		N
AC_0_25MA_2		0.25 mA, 500 Hz		N
AC_0_05MA_2		0.05 mA, 500 Hz		N
AC_0A_2		Open		N
AC10MA	10.0E-3		Start calibration of ac 10 mA range	Y
AC_10MA_3		10.0 mA, 500 Hz		N

Table 13. Adjustment Steps (cont.)

Step	Value Range	Input Signal	Description	Entry Point
AC_5MA_3		5.0 mA, 500 Hz		N
AC_2_5MA_3		2.5 mA, 500 Hz		N
AC_0_5MA_3		0.5 mA, 500 Hz		N
AC_0A_3		Open		N
AC100MA	100.0E-3		Start calibration of ac 100 mA range	Y
AC_100MA_1		100.0 mA, 500 Hz		N
AC_50MA_1		50.0 mA, 500 Hz		N
AC_25MA_1		25.0 mA, 500 Hz		N
AC_5MA_1		5.0 mA, 500 Hz		N
AC_0A_1		Open		N
DCI				
DC100UA	100.0E-6		Start calibration of dc 100 μ A range	Y
DC_P100UA_1		100.0 μ A		N
DC_0A_1		Open		N
DC_N100UA_1		-100.0 μ A		N
DC1MA	1.0E-3		Start calibration of dc 1 mA range	Y
DC_P1_0MA_2		1.0 mA		N
DC_0A_2		Open		N
DC_N1_0MA_2		-1.0 mA		N
DC10MA	10.0E-3		Start calibration of dc 10 mA range	Y
DC_P10MA_3		10.0 mA		N
DC_0A_3		Open		N
DC_N10MA_3		-10.0 mA		N
DC100MA	100.0E-3		Start calibration of dc 100 mA range	Y
DC_P100MA_4		100.0 mA		N
DC_0A_4		Open		N
DC_N100MA_4		-100.0 mA		N

Remote Commands for Calibration

Table 14 alphabetically lists the command set for calibration.

Table 14. List of Commands

Remote Command	Meaning
CALibrate:ABORT	Instruct unit to abort calibration procedure after present step.
CALibrate:BACKUp	Backup to previous entry point in calibration procedure.
CALibrate:CONSt?	Retrieve the value in use of the given calibration constant.
CALibrate:DATE?	Return a CAL date associated with stored calibration constants.
CALibrate:INFO?	Return message or instructions associated with running step.
CALibrate:MOD:DATE <slot>, <year>, <month>, <day>	Set CAL date of module in specified slot.
CALibrate:NEXt [<reference>]	Continue a calibration procedure if it is waiting.
CALibrate:REF?	Return nominal value expected for reference entry.
CALibrate:SECure:STATe <boolean>, <admin_password>	Instruct unit to enable calibration.
CALibrate:SECTion	Skip to next section of calibration procedure.
CALibrate:SKIP	Skip to next entry point in calibration procedure.
CALibrate:STARt <procedure> [, <step>]	Start a calibration procedure.
CALibrate:STATe?	Return state of calibration.
CALibrate:STEP?	Return name of step currently running.
CALibrate:STORe	Store new calibration constants.
CALibrate:MODule:DATE <slot>, <year>, <month>, <day>	Set module CAL date.

Remote Programming Examples

This section gives examples of command sequences for several likely scenarios.

Start a Full Calibration

Table 15 shows an example to run a full calibration.

Table 15. Full Calibration Example

Command	Action
CAL:SEC:STAT OFF,"2638"	Disable the security for calibration.
CAL:STAR MAIN	Start MAIN calibration procedure, and show instruction of MAIN calibration procedure.
CAL:NEXT	Continue to show instruction of ACV calibration.
CAL:NEXT	Continue to perform ACV calibration. After it is completed, show instruction to connect the calibrator to the instrument for ACV calibration.
CAL:NEXT	Show instruction to ask for 100 mV/1 kHz signal input, and the reference value.
CAL:NEXT 0.1	Continue to perform measurements for this point, after it is completed, show instruction to ask for 50 mV/1 kHz signal input and the reference value.
CAL:NEXT 0.05	Continue to perform measurements for this point, after it is completed, show instruction to ask for 25 mV/1 kHz signal input and the reference value.
CAL:NEXT 0.025	Continue to perform measurements for this point, after it is completed, show instruction to ask for 5 mV/1 kHz signal input and the reference value.
CAL:NEXT 0.005	Continue to perform measurements for this point, after it is completed, show instruction to ask for 0V signal input and the reference value.
CAL:NEXT 0.0	Continue to perform measurements for this point, after it is completed, calculate the calibration constants for ac 100 mV range, then show instruction to ask for 1 V/1 kHz signal input and the reference value (the first calibration point of next ac 1 V range).
...	...
CAL:STOR	Store the calibration constants.
CAL:ABOR	Abort the calibration procedure.

Calibrate 1 V DC Range only

Table 16 shows an example to run a calibration for 1 V dc.

Table 16. 1 V DC Calibration Example

Command	Action
CAL:SEC:STAT OFF,"2638"	Disable the security for calibration.
CAL:STAR MAIN,DC1V	Start MAIN calibration procedure, and jump to 1 V dc range directly, it will show ask for 1 V signal input, and the reference value.
CAL:NEXT 1	Continue to perform measurements for this point, after it is completed, show instruction to ask for 0 V signal input and the reference value.
CAL:NEXT 0	Continue to perform measurements for this point, after it is completed, show instruction to ask for -1 V signal input and the reference value.
CAL:NEXT -1	Continue to perform measurements for this point, after it is completed, calculate the calibration constants for DC 1V range, then show instruction to ask for 10 V signal input and the reference value (the first calibration point of next 10 V dc range).
CAL:STOR	Store the calibration constants.
CAL:ABOR	Abort the calibration procedure.

Write Calibration Date to a Module

Table 17 shows an example to write the calibration date into a module after the CJC accuracy is validated.

Table 17. Write Calibration Date to a Module Example

Command	Action
CAL:SEC:STAT OFF,"2638"	Disable the security for calibration.
CAL:MOD:DATE 1,2014,11,1	Write "2014/11/1" as new calibration date into module in slot 1.

Command References

CALibrate:ABORt

Description: Instruct unit to abort calibration procedure after present step.

Example: CAL:ABOR

Related Commands:

CALibrate:STATe?

CALibrate:BACKup

Description: Backup to previous entry point in calibration procedure.

Example: CAL:BACK

Related Commands:

CALibrate:SKIP

CALibrate:SECTion

CALibrate:CONST? "<cco_name>"

Description: Retrieves the value in use of the given calibration constant.

Example: CAL:CONS? "DC100MV_A1"

Response: -1.401686110719e-04

Related Commands:

CALibrate:SECure:STATe

CALibrate:STORe

CALibrate:DATE?

Description: Return a CAL date associated with stored calibration constants.

Example: CAL:DATE?

Response: 2013,11,1

Related Commands:

CALibrate:MODule:DATE?

CALibrate:INFormation?

Description: Return message or instructions associated with running step

Example: CAL:INFO?

Response: "Connect calibrator to Volt terminals"

Related Commands:

CALibrate:STATe?

CALibrate:STEP?

CALibrate:MODule:DATE <slot>,<year>,<month>,<day>

CALibrate:MODule:DATE? <slot>

Description: Set and query module calibration date.

Example: CAL:MOD:DATE 1,2013,11,1

CAL:MOD:DATE? 1

Response: 2013,11,1

Related Commands:

CALibrate:SECure:STATe

CALibrate:NEXT [<reference>]

Description: Continue a calibration procedure if it is waiting. An optional parameter reference value (used if it's waiting for a reference), If the reference value has no unit, the unit is assumed to be that returned by the CAL_REF? command.

Example: CAL_NEXT

CAL_NEXT 2.999987

CAL_NEXT 100 mV

Related Commands:

CALibrate:REFerence?

CALibrate:BACKup

CALibrate:SKIP

CALibrate:REference?

Description: Return nominal value expected for reference entry

Example: CAL:REF?

Response: 3.000000e+00

Related Commands:

CALibrate:NEXT

CALibrate:STATE?

CALibrate:INFORMATION?

CALibrate:STEP?

CALibrate:SECure:STATE <boolean>, <admin_password>

Description: Instruct unit to enable calibration

Example: CAL:SEC:STATE OFF,"1586"

Related Commands:

CALibrate:SECure:STATE?

CALibrate:SECure:STATE?

Description: Query calibration enable state

Example: CAL:SEC:STAT?

Response: 1

Related Commands:

CALibrate:SECure:STATE

CALibrate:SECTion

Description: Skip to next section of calibration procedure.

Example: CAL:SECT

Related Commands:

CALibrate:BACKup

CALibrate:SKIP

CALibrate:SKIP

Description: Skip to next entry point in calibration procedure.

Example: CAL:SKIP

Related Commands:

CALibrate:BACKup

CALibrate:SECTion

CALibrate:START <procedure> [, <step>]

Description: Start a calibration procedure. As parameter, the name of procedure should be provided (MAIN is the procedure for full instrument calibration), an optional parameter <step> can be provided to start from, if it is omitted, it starts at the beginning. Before any calibration procedure can be started, the calibration secure state should be disabled.

Example: CAL_START MAIN
CAL_START MAIN, DC1V

Related Commands:

CALibrate:SECure:STATE

CALibrate:STATE?

Description: Return state of calibration

Example: CAL:STAT?

Response: RUN - running a calibration step

REF - waiting for a CAL_NEXT with reference
(measurement) value

INS - instruction available, waiting for a CAL_NEXT

NOT - not in a calibration procedure (or at end of one)

Related Commands:

CALibrate:STEP?

CALibrate:REFerence?

CALibrate:INFOrMation?

CALibrate:STEP?

Description: Return name of step currently running

Example: CAL:STEP?

Response: DC1V

Related Commands:

CALibrate:STATE?

CALibrate:REFERENCE?

CALibrate:INFORMATION?

CALibrate:STORE

CALibrate:STORE?

Description: Store new calibration constants or query whether a cal store is needed.

Example: CAL:STOR

CAL:STOR?

Response: 1 is yes, 0 if no



Related Commands:

CALibrate:SECure:STATE

User-Replaceable Parts and Accessories

Table 18 lists the part numbers of each user-replaceable part or accessory for the Product, see Figure 11.

Table 18. User-Replaceable Parts and Accessories

Item	Fluke Part Number	Qty	Description
①	4281998	1	FLUKE-1586A-2010, 2638A HANDLE
②	4281980	1	FLUKE-1586A-2009, 2638A FRONT PANEL BOOT
③	4281971	1	FLUKE-1586A-2008, 2638A REAR PANEL BOOT
④	4396173	1	FLUKE 1586A-2586 RELAY CARD
⑤	4374731	1	FLUKE-1586A-2586, 2638A, PROTECTIVE SLOT COVER
⑥	4338362	1	FLUKE-2638A, REAR SLOT FRAME
⑦	4357143	6	SCREW,4-40 X 0.375 IN.,FLAT,PHILLIPS,SS,PASSIVATED,LOCK PATCH,ROHS COMPLIANT
⑧	Contact Fluke	1	FLUKE 1586A-2586 HI-CAPACITY MODULE
Not Shown	1588940	1	BATTERY,PRIMARY,LI- MNO2,3V,560MAH,COIN,CR2450,24X5MM,BULK
Not Shown	Contact Fluke	1	Transit Case
Not Shown	Contact Fluke	1	DIO/ALARM connectors for 2638A
Not Shown	4121552	1	884X-4GB,USB MEMORY, 4GB
Not Shown	4298499	1	CABLE, USB MALE A TO MALE B, 2M
Not Shown	884X- ETH	1	884X-ETH, ETHERNET INTERFACE CABLE, 1m
Not Shown	N/A	1	2638A-ETH,ETHERNET INTERFACE CABLE, 2m
Not Shown	Variable [3]	1	Test lead set [3]
Not Shown	4394437	1	 FUSE,0.16A,250V,SLOW,0.5 I2T,6X32MM,CERAMIC [2]
Not Shown	166306	1	 Fuse 0.25A, 250V (slow blow) [2]
Not Shown	4107865	1	Product CD (Contains Manuals and USB drivers)
<p>[1] Quantity of items listed can vary based on kit or model ordered. [2] Only use exact replacements. [3] See www.fluke.com for more information about the test leads for your region.</p>			

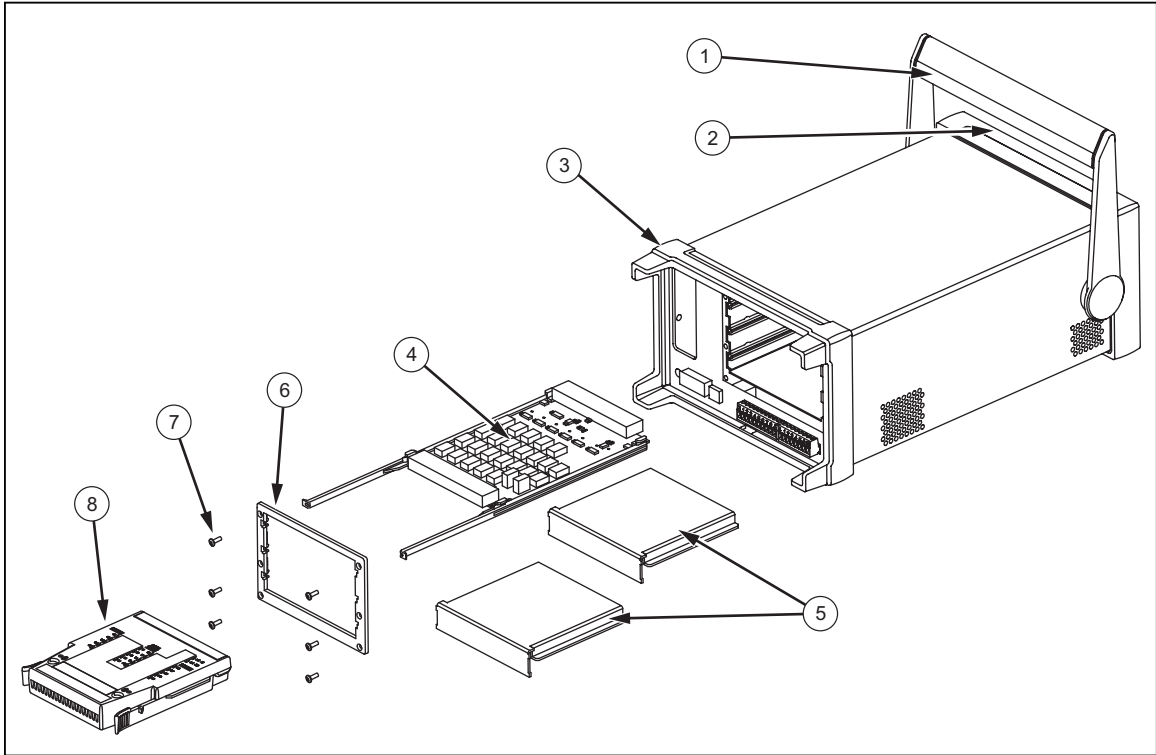

hcn310.eps

Figure 11. Replaceable Parts