

OMRON

Programmable Terminals

NS Series

NS-series Screen Development Software

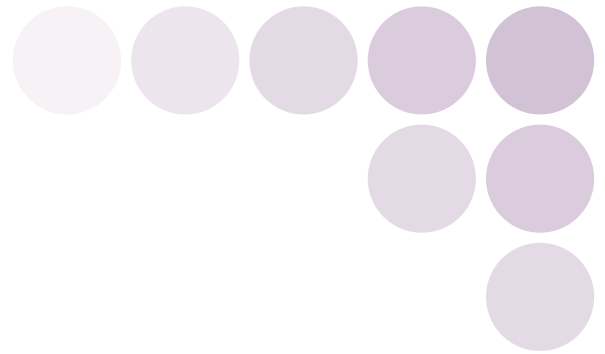

NS

Real Value and Flexible Application

Provides the Functions Sought in New Displays.
This Powerful Lineup Showcases OMRON's Unique Value.

SERIES

realizing

Navigator for System
NS Series

NS-series Value

Perfect Synergy

Best Match

Demonstrates excellent matching with OMRON control devices. Greatly reduces the cost and effort required to connect all kinds of components, such as PLCs. Provides a wide variety of useful functional aspects of the same manufacturer.

- Eliminates Programming and Screen Designing..... P6
- SAP Library..... P7
- Single Port Multi Access (SPMA)..... P8
- Ladder Monitor..... P8
- PLC Data Trace..... P9
- PLC Troubleshooter..... P9
- Direct Connection to Temperature Controllers..... P9
- Face Plate Auto-Builder for NS..... P10
- 260,000-color Video Display..... P10

Simple Screen Designing

Easy-to-use Software

The CX-Designer is so easy-to-use that anyone can master it, without even designing screens and ladder programs. You can create the desired screens quickly and with OMRON's integrated development environment, you can dramatically reduce the time required to design screens.

- User-friendly Screen Creation..... P11
- Reading the Symbol Table..... P12
- Reading Another Project's Screens and Objects..... P13
- Integrated Simulation with the PLC Ladder Program..... P13
- Editing of Multiple Objects..... P14
- Editing of Overlapping Objects..... P14
- Programming with Symbols..... P14

Complete Functionality

Plenty of Basic Functions

The basic functions desired in new displays have been greatly improved. In addition to making the displays as easy-to-use as possible, a variety of useful functions that can precisely meet the customers' needs have been built into the displays.

- Multi-language Support..... P15
- FTP Function..... P15
- Plentiful Graphing Functions..... P16
- Screen Data Security Functions..... P17
- User Security Functions..... P17
- Huge 60-MB Image Memory..... P17
- Connect! Expand! Feel the NS Series, the power of networking..... P18

NS Series Lineup

This powerful lineup showcases OMRON's unique value. Choose from 3 types to match your application and requirements.

NS Series Plentiful screen variations and diverse functions allow use in a wide variety of applications.

Standard Models

5.7 inches



NS5-MQ Monochrome STN



- 16 monochrome gradations
- QVGA 320 x 240 pixels
- Screen memory size: 20 MB

NS5-SQ Color STN



- 4,096 colors
- QVGA 320 x 240 pixels
- Screen memory size: 20 MB

NS5-TQ Color TFT



- 32,768 colors
- QVGA 320 x 240 pixels
- Screen memory size: 20 MB

8.4 inches



NS8-TV Color TFT



- 32,768 colors
- VGA 640 x 480 pixels
- Screen memory size: 60 MB

10.4 inches



NS10-TV Color TFT



- 32,768 colors
- VGA 640 x 480 pixels
- Screen memory size: 60 MB

12.1 inches



NS12-TS Color TFT



- 32,768 colors
- SVGA 800 x 600 pixels
- Screen memory size: 60 MB

Optional Products NS-series functions, such as image processing and networking, have been expanded.



**Video Input Unit
NS-CA001**
• NTSC/PAL video inputs (4 channels)



**RGB/Video Input Unit
NS-CA002**
• NTSC/PAL (2 channels)
• RGB input (1 channel)



**Controller Link Interface Unit
NS-CLK21**



**RS-232C/RS-422A Conversion Unit
NS-AL002**
• Transmission distance: 500 m max.



**Communications Cable
XW2Z-S002**

NSH Series A hand-held version of the NS5 is now available to perform operations at the production site.

Hand-held Models

5.7 inches



**NSH5-SQR
Color STN**
• Equipped with a red switch for an emergency stop input.
• 4,096 colors
• QVGA 320 x 240 pixels
• Emergency stop (3 inputs)



**NSH5-SQG
Color STN**
• Equipped with a gray switch for a stop input.
• 4,096 colors
• QVGA 320 x 240 pixels
• Emergency stop (3 inputs)

Hand-held PT Cable



SYSMAC One NSJ Series

PT is unified with the Controller into one package to greatly help standardize equipment and reduce size.

Integrated Controller Models

5.7 inches



NSJ5-TQ□□-M3D Color TFT



- (Display Section)
- 32,768 colors
 - QVGA 320 x 240 pixels
 - Screen memory size: 20 MB
- (Controller Section)
- I/O points: 640
 - Program capacity: 20K steps
 - Data Memory: 32K words

NSJ5-SQ□□-M3D Color STN



- (Display Section)
- 4,096 colors
 - QVGA 320 x 240 pixels
 - Screen memory size: 20 MB
- (Controller Section)
- I/O points: 640
 - Program capacity: 20K steps
 - Data Memory: 32K words

NSJ5-TQ□□-G5D Color TFT



- (Display Section)
- 32,768 colors
 - QVGA 320 x 240 pixels
 - Screen memory size: 20 MB
- (Controller Section)
- I/O points: 1,280
 - Program capacity: 60K steps
 - Data Memory: 128K words

NSJ5-SQ□□-G5D Color STN



- (Display Section)
- 4,096 colors
 - QVGA 320 x 240 pixels
 - Screen memory size: 20 MB
- (Controller Section)
- I/O points: 1,280
 - Program capacity: 60K steps
 - Data Memory: 128K words

8.4 inches



NSJ8-TV□□-M3D Color TFT



- (Display Section)
- 32,768 colors
 - VGA 640 x 480 pixels
 - Screen memory size: 60 MB
- (Controller Section)
- I/O points: 640
 - Program capacity: 20K steps
 - Data Memory: 32K words

NSJ8-TV□□-G5D Color TFT



- (Display Section)
- 32,768 colors
 - VGA 640 x 480 pixels
 - Screen memory size: 60 MB
- (Controller Section)
- I/O points: 1,280
 - Program capacity: 60K steps
 - Data Memory: 128K words

10.4 inches



NSJ10-TV□□-G5D Color TFT



- (Display Section)
- 32,768 colors
 - VGA 640 x 480 pixels
 - Screen memory size: 60 MB
- (Controller Section)
- I/O points: 1,280
 - Program capacity: 60K steps
 - Data Memory: 128K words

12.1 inches



NSJ12-TS□□-G5D Color TFT



- (Display Section)
- 32,768 colors
 - SVGA 800 x 600 pixels
 - Screen memory size: 60 MB
- (Controller Section)
- I/O points: 1,280
 - Program capacity: 60K steps
 - Data Memory: 128K words

Note: For details on the NSJ-series Controllers, refer to the NSJ-series Programmable Controllers Catalog (Cat. No. V406).

Best Match

Best Match with OMRON Products, Eliminates Programming and Screen Designing

The Smart Active Parts (SAP Library) for the NS Series makes it easy to connect to OMRON PLCs and components, without creating ladder programs and screen data. OMRON provides a development environment that requires with no programming and no screen designing.

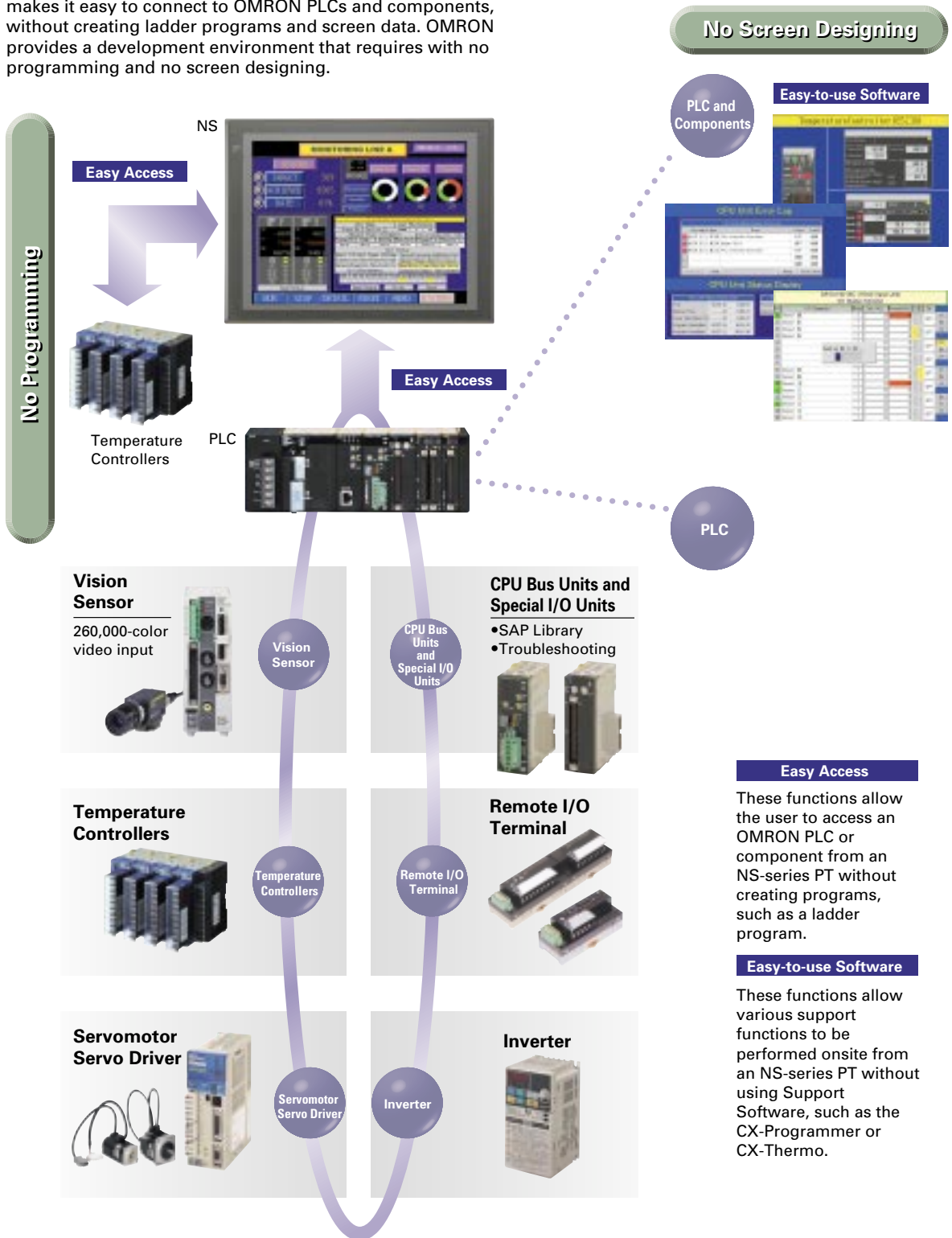

Smart Active Parts (SAP Library)

Easy Access

Standard Feature

Dramatically reduces the effort required to create ladder programming and screens.

More than 2,000 Library parts (Smart Active Parts) are available, which can directly access OMRON PLCs and components. The objects can just be pasted from the Smart Active Parts (SAP Library) Library to the screen; it is completely unnecessary to create screens and ladder programming.

CX-Designer Screen Design Software



SAP Library, Temperature Controller Parts



The Temperature Controller's setting and monitor screens are completed in no time.

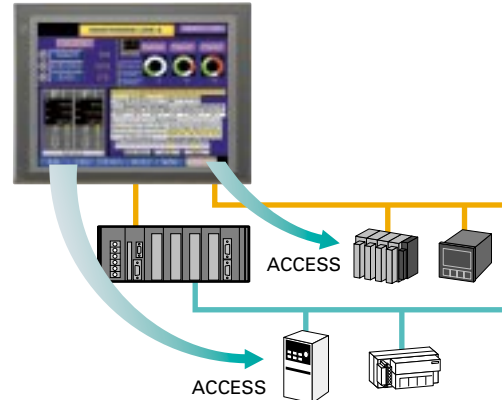

Support tool objects can be incorporated to check for errors and make settings, even without a computer.

Plenty of support tool objects (the Tool Function SAP Library) are available, which can be easily incorporate support tool functions in the NS-series PT. Just paste the support tool objects in the screen to check for errors and make settings,

Example screens using support tool objects (Tool Function SAP Library)

From

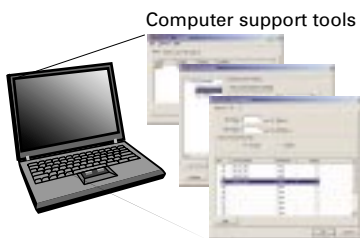

To

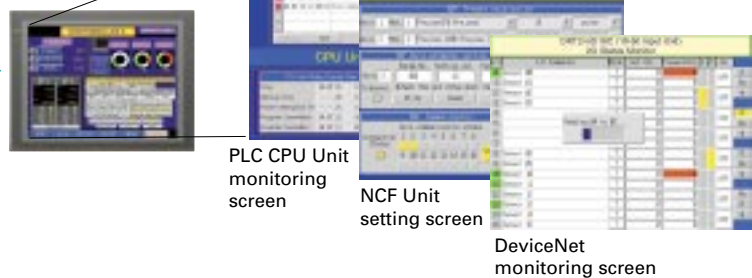

CPU Bus Unit and Special I/O Unit Troubleshooting Can Be Also Performed with the SAP Library.

Easy Access

A Troubleshooter SAP Library is available to troubleshoot each Unit in the PLC. When an error occurs in a Unit, the Troubleshooter SAP Library provides an easy-to-understand explanation of the cause of the error as well as the countermeasures.

Troubleshooter SAP for a Position Control Unit

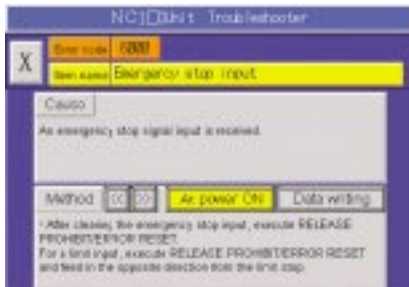

Troubleshooter SAP for a DeviceNet Unit

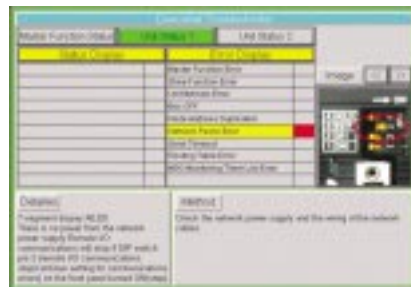

We plan successive development of the following Troubleshooter SAP Libraries.

New versions of the SAP Libraries for the Analog Input Units, Analog Output Units, Analog I/O Units, ID Sensor Units, Temperature Sensor Units, and Fast Counter Units will be available soon.

Compatibility

Screen Design Software

Basic Functions

Specifications

Single Port Multi Access (SPMA)

Easy Access

Standard Feature

The ladder program and screen data can be transferred from a single port!

The ladder program can be transferred through the PLC and the PT's screen data can also be transferred, all while the computer remains connected to the PT's port (such as a USB port).

The PT can transfer data over network levels by the following routes.

Computer (USB) → NS-series PT (Serial) → PLC (Ethernet or Controller Link) → PLC

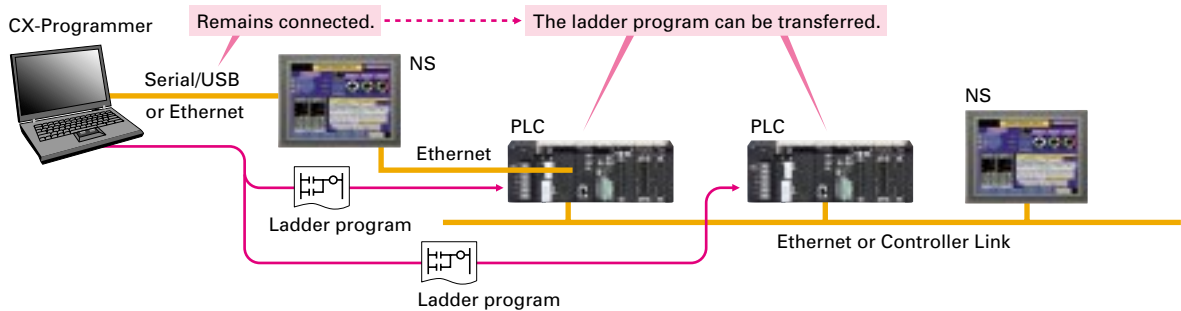

SPMA significantly improves maintenance efficiency when the NS-series PT and PLC are some distance apart.

Computer (USB) → PLC (Serial) → NS-series PT

Note: SPMA can be used in CS/CJ-series PLCs with lot number 030201 or later.

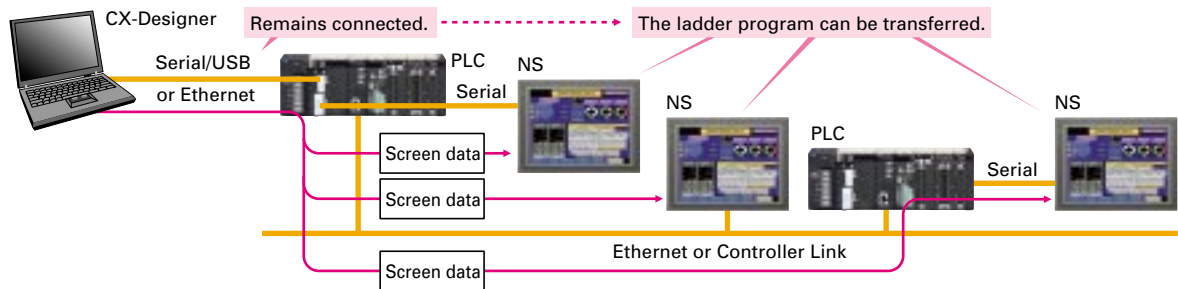

Ladder Monitor

The ladder program can be monitored onsite without a laptop!

Ladder programs with I/O comments can be monitored on the PT's screen and the ladder program can also be edited with the Programming Console function.

Note: The Ladder Monitor function is not supported by the 5.7-inch models, but the Programming Console function can be used if the required software is copied to the Memory Card.

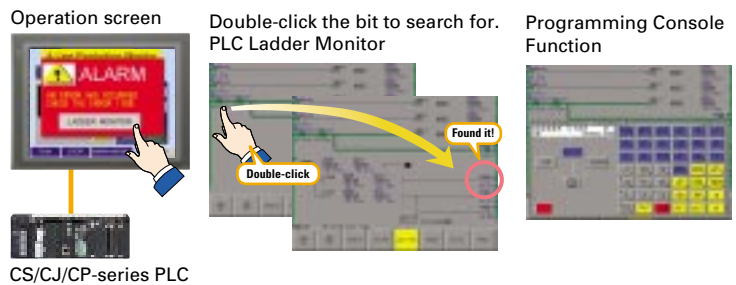

Also meets the requirements of users who need to display devices onsite, instead of the ladder program.

Easy Support Tools Standard Feature

[Switch Box Function]

The operator can check the PLC status by displaying just the I/O comments and status.

[Device Monitor Function]

Displays the device's contents, allowing settings to be input and checked and making startup operations more efficient.

Switch Box Function



Device Monitor Function



PLC Data Trace

Easy Support Tools

Standard Feature

The PLC's operation can be checked!

The PLC Data Trace function is built into the PT in addition to the Ladder Monitor and Device Monitor. A bit's status and operation can be viewed in a time chart just by setting the desired PLC bit's address in the PT.

Note: There are differences between this Data Trace function and the CX-Programmer's Data Trace function. Refer to the NS-series Programmable Terminal Programming Manual (Cat. No. V073) for details.

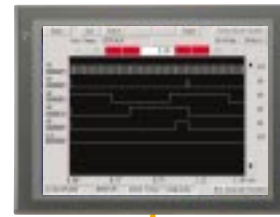

Data Trace

CS/CJ/CP-series PLC



PLC Troubleshooter

Easy Support Tools

Constantly monitors PLC errors.

Automatically detects PLC errors and displays the error details and recovery procedure on the screen. Even if a problem occurs, it can be resolved quickly without referring to the manuals.



Error details are displayed.

Processing procedure is displayed.



CS/CJ/CP-series PLC

Note: A special template is required when using this function. Contact your OMRON representative for details. This function is a standard feature in the NSJ-series PTs.

Direct Connection to Temperature Controllers

Easy Access

Standard Feature

Connect OMRON Temperature Controllers directly to the NS-series PT.

OMRON Temperature Controllers can be connected directly to the NS-series PT's RS-232C port. Data does not pass through the PLC, so ladder programming is not required. Also, there are plenty of objects in the SAP Library for Temperature Controllers, and Temperature Controller screens can be created easily just by pasting objects from the SAP Library to the screens.



CJ1W-CIF11
RS-422A Serial Adapter



OMRON Temperature Controllers

Note: An RS-422A Serial Adapter is needed to connect directly to a Temperature Controller. Refer to page 34 for a list of the Temperature Controllers that can be connected.

Screens for Loop Controllers can be easily and automatically created.

Compatibility with CX-Process Is Also Outstanding.

WS02-NSFC1-EV3 Face Plate Auto-Builder for NS

Significantly reduces the effort required to combine a Loop Controller with an NS-series PT.

- Easy automatic generation of faceplates, such as faceplates for PV monitoring and SV setting, as well as tuning screens, such as screens to set and autotune PID constants.
- A total of 17 function blocks are supported, with eleven function blocks, such as Ratio Setting and Motor Manipulators newly supported (version 3 of higher).
- Comments are automatically entered for automatically assigned unit and scale settings when a project is generated (version 3 and higher).

Note: Refer to the PLC-based Process Control Catalog (Cat. No. P051) and the Loop-control CPU Unit Catalog (Cat. No. R128) for details on Loop Controllers.



CX-Process Tool
(Loop Controller Programming Software)
● Loop Controller program creation (function block method)
● CSV tag file output

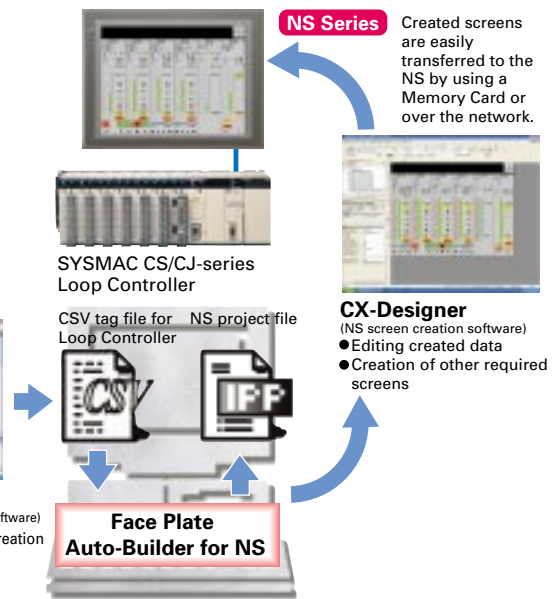

260,000-color Video Display

Equipment and workpiece movements can also be displayed in beautiful video!

Two kinds of video interfaces are available to connect to various applications. Provides compatibility with OMRON Vision Sensors (F150, F160, and F250) in addition to video and CCD camera connections. A Console Unit is not needed to connect, either.

NS-CA001 Video Input Unit

Four video inputs or CCD cameras can be connected and up to four images can be displayed simultaneously if the image size is 320x240 pixels.

NS-CA002 RGB/Video Input Unit

There is an analog RGB input terminal in addition to the two video input terminals. Either of the video signals or the analog RGB signal can be displayed on the NS-series PT.

Note: Some models of Video Input Units and RGB Video Input Units cannot be used. For details, refer to page 4.

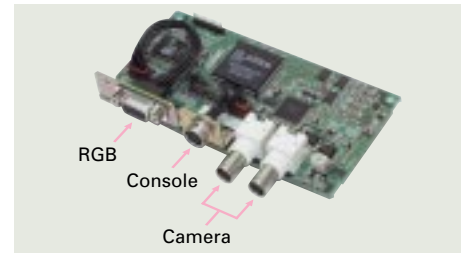
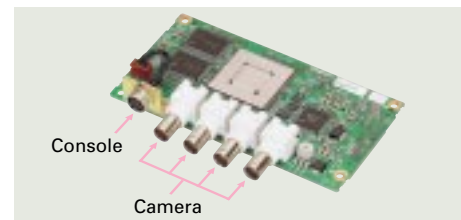

Also Compatible with OMRON Vision Sensors.

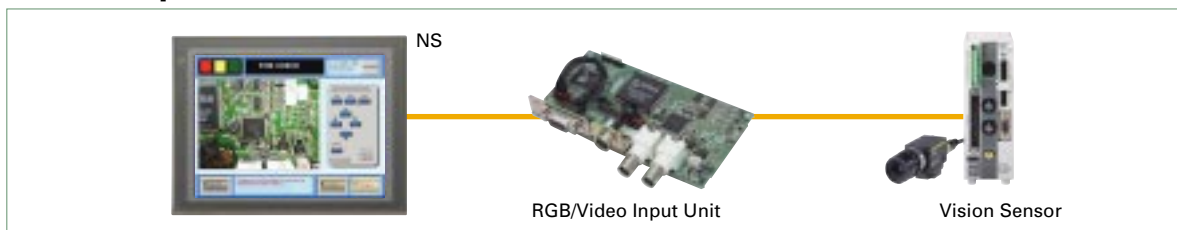

User-friendly Screen Creation

So easy to use, anyone can master it.

Without screen creation and ladder programming, the CX-Designer Screen Design Software is so easy-to-use that anyone can master it.

 **All addresses and comments can be managed using a single Symbol Table.**

Shows a list of addresses, names, and comments used in project screen data. Addresses, names, and I/O comments for the CX-Programmer can also be imported.

 **Improved Icons and Help**

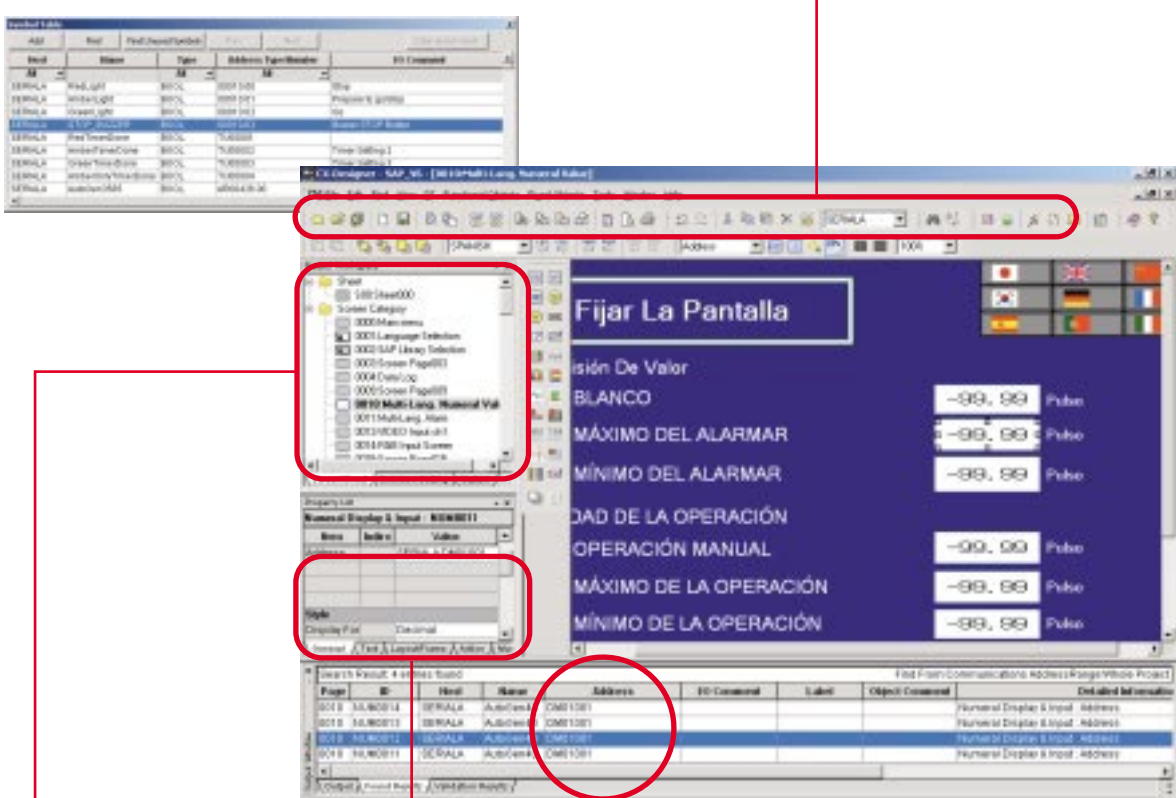

 **The project Workspace enables the user to look through the entire project.**

- Screens you want to edit can be opened right away.
- Perform screen management, such as copying or deleting screens, by simply right-clicking.
- Reusing screens from other projects is easy with the CX-Designer.
- Settings for alarms, data logs, communications, and other functions can be easily accessed.

 **Drastically reduce the number of clicks in the project.**

Just click on the object once to display or change properties. Multiple objects can be selected to display and change shared properties all at once.

 **The Output Window shows search results.**

In addition to addresses and I/O comments used in screen data, labels can also be used as search strings and the results can be displayed.

Reading the Symbol Table

Dramatically reduces the need to manually input data such as addresses and I/O comments.

The symbol table created in the CX-Programmer during ladder programming can be read into the CX-Designer by dragging and dropping, so it isn't necessary to manually data such as input addresses and I/O comments.

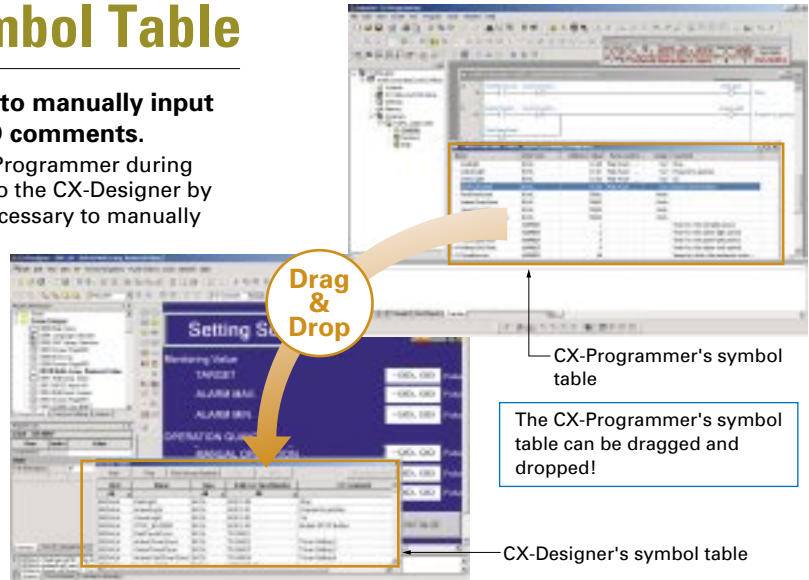

● Example of Reading the Symbol Table

The symbol table read from the CX-Programmer can be directly dragged and dropped to the touch switch and lamp.

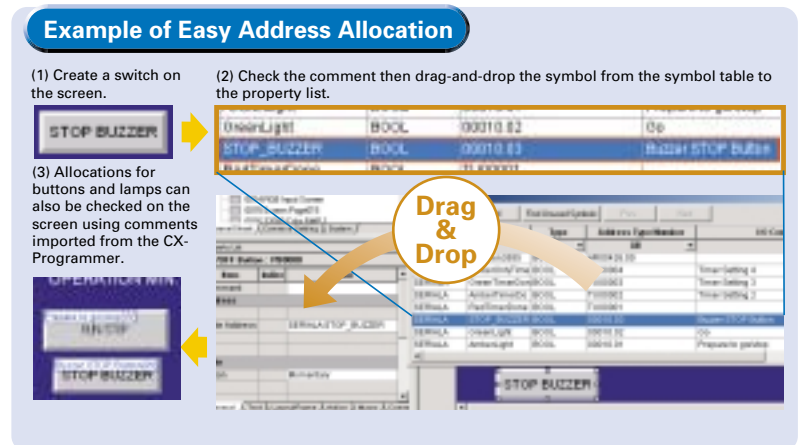

● Example of Reading I/O Comments

If Use I/O comment is selected in advance for the Use symbol text as label, the I/O comments are automatically used as labels when addresses are dragged and dropped from the symbol table. (If Use symbol names is selected, the symbol names are used as the labels.)

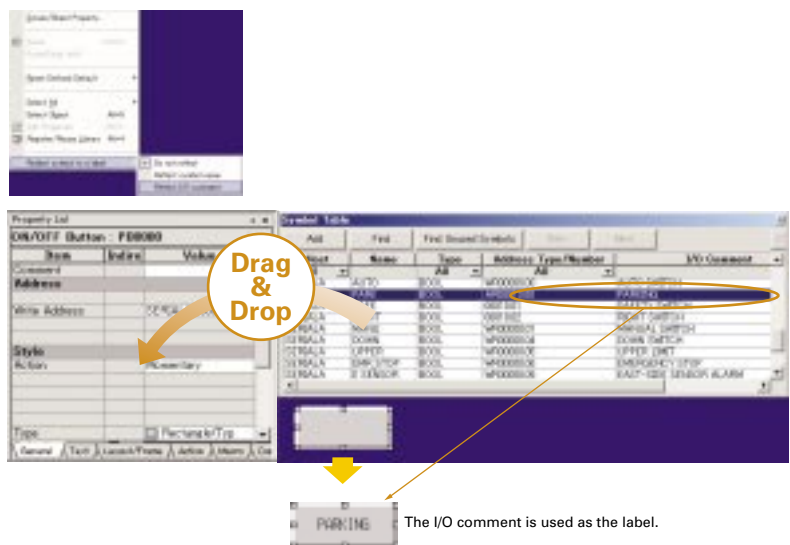

Reading Another Project's Screens and Objects

Easily reuse screen resources by dragging and dropping them.

Resources from another project can be easily reused by just selecting the screen or objects that you want to read and dragging and dropping it, so screens can be created intuitively.

[Example screen 1]

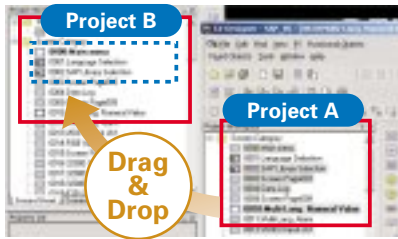

Select the screen that you want to read, drag it to the destination, and drop it.

[Example screen 2]

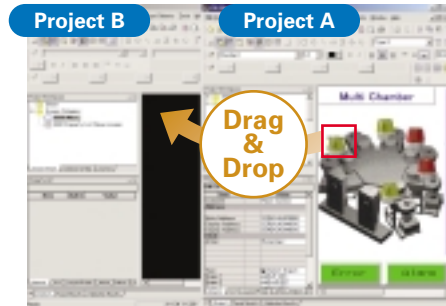

Select the part that you want to read, drag it to the destination, and drop it.

Integrated Simulation with the PLC Ladder Program

The screen data and ladder program can be checked simultaneously in the computer.

The CX-Designer and CX-Programmer interconnects the test functions in the computer through the CX-Simulator. The screens and ladder program checks are performed simultaneously, which significantly increases debugging efficiency.



Editing of Multiple Objects

Objects can be edited very efficiently in a list!

Addresses and other settings, such as labels and colors, can be set together in a list, making editing operations much more efficient.

The attributes of multiple parts can be edited together, too.

When the common attributes (such as background color and text color) of multiple parts are being changed, the attributes can be changed together using the property list.

[Example screen 1] After editing the settings in the list, press the OK Button to make the new settings effective immediately.

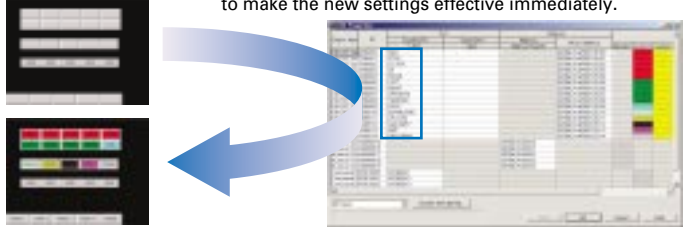

[Example screen 2] If the background color is changed from white to gray in the property list, the background color is changed for all of the selected objects.

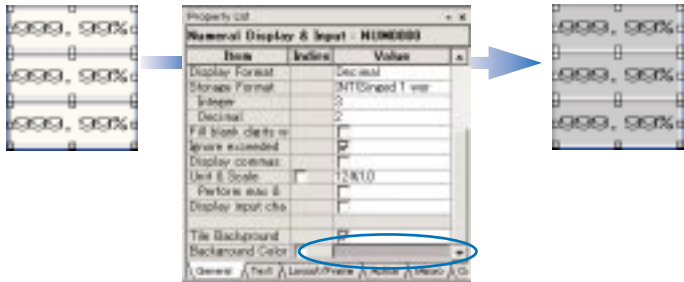

Editing of Overlapping Objects

The Select Object command and filter function are the solution for overlapping objects!

The Select Object command is a powerful tool when you want to edit object hidden by overlapping. A filter function can also be used to aid editing by displaying only the objects to be edited.

[Object Selection Window]

Right-click and select Select Part to display the objects (all types) on the screen.

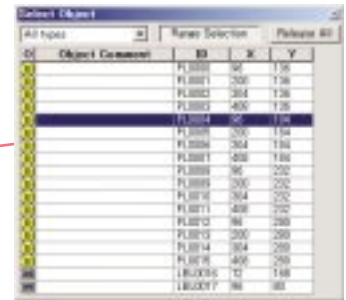

[Filter Function]

Use the Select Part command's filter function to select the objects (ON/OFF Button) that you want to edit.

Only the edited object is displayed and it can be edited easily.



Programming with Symbols

Screens can be created even when addresses are unknown.

Screens can be created even if the addresses have not been determined. Addresses can be input as either names or actual addresses and the addresses can be input from the symbol table after the addresses are determined.



Symbols input for addresses, which have not yet been determined.



Addresses input as addresses because addresses have been determined.



[Inputting from the Symbol Table]

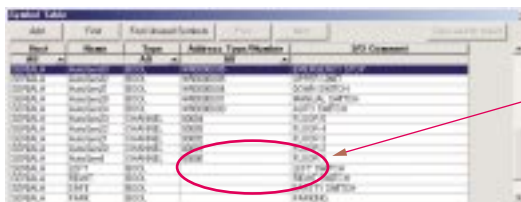

Addresses are input in the symbol table after the addresses are determined.

Plenty of Basic Functions

Multi-language Support

There are 41 languages supported and useful label switch functions are also built into the PT. Unicode is supported and 41 Asian and European languages can be combined in screens. Also, it is possible to switch between up to 16 labels using the label switching function, so it is possible to support up to 16 languages in a single screen just by specifying the language to be displayed in each label.

NS Series



[The labels' text attributes can also be reflected when importing.]

When screen data is imported, text attributes can be applied to the specified labels and attributes such as the font and text color can be reflected to other languages labels.

Multi-language CSV data

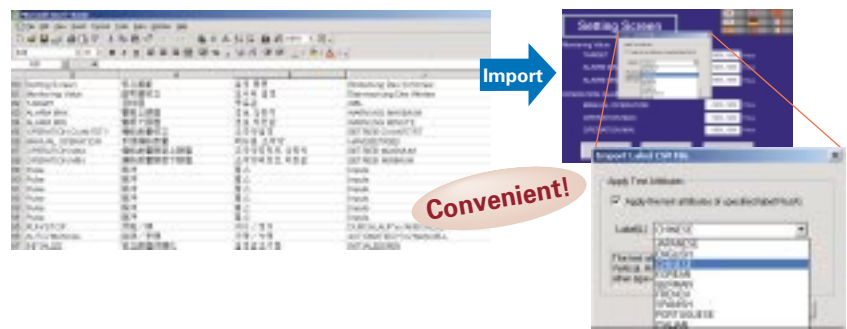

Multi-language conversion has become much easier.

The screen data in the source language is exported to a CSV file and sent to a translation agency by e-mail for translation. Later, the translated CSV file is just imported to easily provide multi-language support.

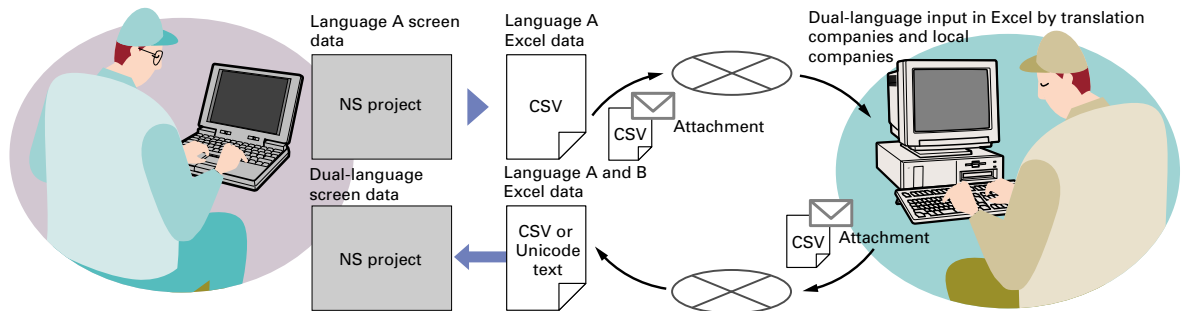

Note: Windows 2000 or XP is required for multi-language support.

FTP Function

You can partially replace text and pictures from your computer.

FTP (File Transfer Protocol) has been added! Texts, lists, and recipes can be replaced with the put/get command from your computer! You can even replace BMP files from your computer easily.

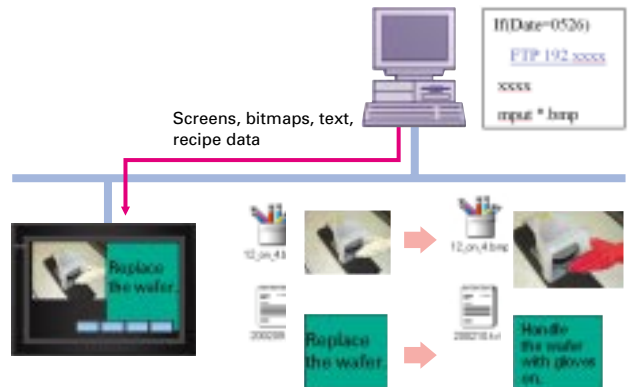

Plenty of Basic Functions

Plentiful Graphing Functions

A device's operation is easier to understand when presented visually.

A variety of graphing functions are built into the PTs, such as the trend graph, which can log data over a long term, and the line graph, which can display overlapping graphs. A device's operation is easier to understand when presented visually.

• **Long-term data logging and storage are also easily achieved.**

[Trend Graph (Data Log) Function]

Logging data is stored as a CSV file in the Memory Card mounted in the NS-series PT. The data stored in the Memory Card can be read or deleted from the screen.

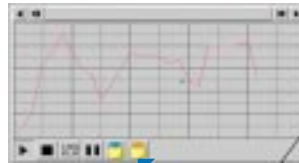

The log data files in the Memory Card appear as shown below when the read file button is pressed.



A log can be saved automatically, without any programming, just by selecting the Save the data periodically Option in the Data Log Setting Window.

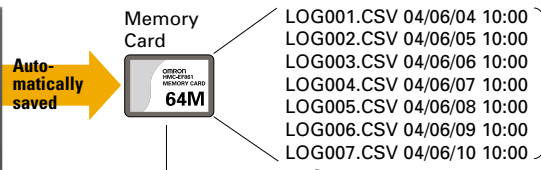

Auto-
matically
saved

Logging data for each day (43,200 points) is saved in the Memory Card in CSV format.

It is possible to make a one-week log by automatically saving the data seven times.

Suffixes are automatically added to file names set in the CX-Designer.

• **The earlier line graph function as been further improved.**

[Line Graph Function]

The data logged by the PLC can be displayed in overlapping graphs, so a device's operation can be compared for evaluation and analysis. In addition, up to 1,000 words of consecutive data can be displayed as a line graph, data can be displayed together, and any region can be magnified.

(1) Graphs can be superimposed.



(2) The display can be magnified.

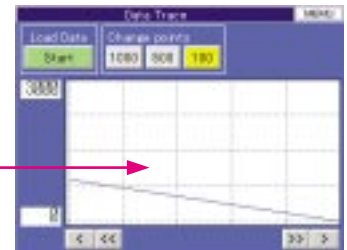
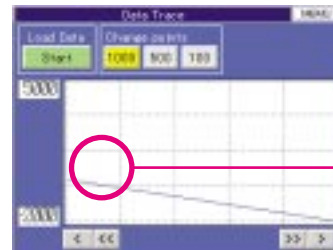

• **Any position from the host (PLC) can be plotted as a graph.**

[Continuous Line Function]

A graph can be plotted in any position by specifying the X and Y coordinates of the vertices. Also, the graph can be moved on the screen by specifying the movements from the PLC.

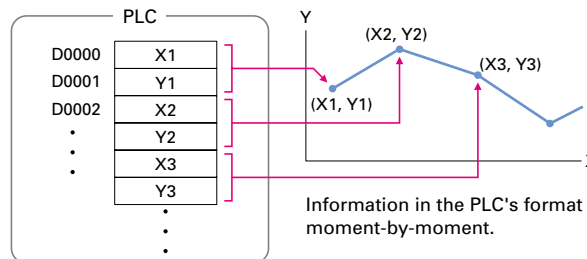

Information in the PLC's format can be plotted moment-by-moment.

Screen Data Security Functions

Protect important screen data with a password.

If password protection is set in the data transfer security settings when the screen data is designed, a password must be entered to download or upload the screen data, so important screen data can be protected.

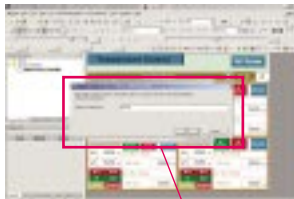
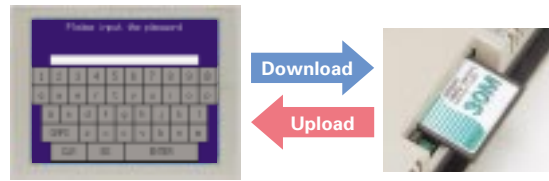

Security password

A password between 4 and 64 characters long can be set. The download/upload will start if the user inputs the password that was set when the screen was designed. (Password input will be disabled if the wrong password is input 3 times in a row.)

If a password has been set, the password is required to transfer screen data (download or upload) with the Memory Card.

User Security Functions

Operator access rights and the operating format can be set to one of five password levels.

Each operator can be given one of 5 password levels using the User Security (level authentication) function. A password level can be set for each object, so various objects can be made inoperable or hidden based on the operator's access level.

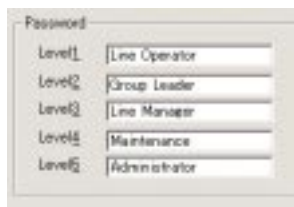

High
Level 5
Level 4
Level 3
Level 2
Low
Level 1

Operator passwords are managed in 5 levels. Passwords can be up to 16 characters long and the access rights increase as the level number increases.



The operator cannot manipulate objects with a password level (authentication level) higher than the operator's login level.

Huge 60-MB Image Memory

Real images can be used liberally, without worrying about memory capacity!

The industry's highest standard image memory: 60 MB. Take full advantage of the 32,768-color palette and spacious memory to design realistic images.

Note: The standard image memory of the 5.7-inch models (NS5, NSH5, and NSJ5) is 20-MB.



When an error occurs, the location of the error can be shown realistically in a picture.

Connect! Expand! Feel the NS Series, the power of networking.

Provides serial NT Link communications supporting both 1:1 and 1:N connections. The NT Link has more efficient communications than Host Link and its capabilities are especially apparent in applications with multiple PTs connect to the PLC. The NS-series PTs can also support communications with multiple PLCs and multiple NS-series PTs through Controller Link and Ethernet connections, so the network can be configured freely to match the requirements and scale of the application.

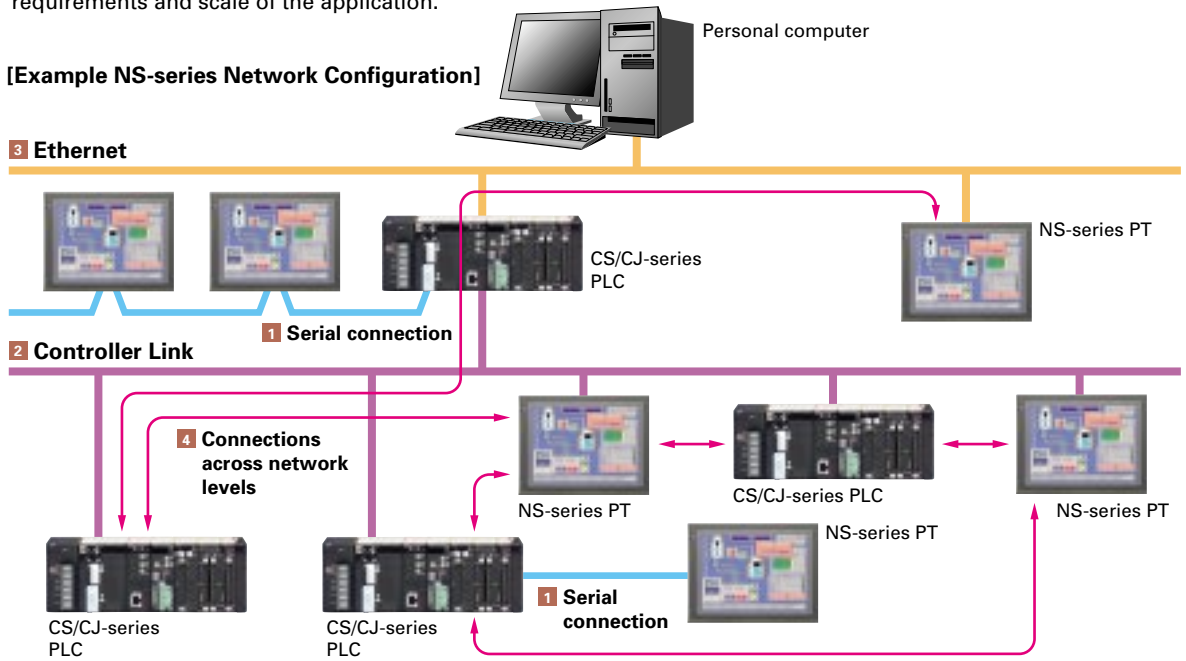

1 Serial connection

1:1 NT Link or Host Link

- NS:PLC = 1:1

Connecting with the PLC through port A or port B



- NS:PLC = 1:2

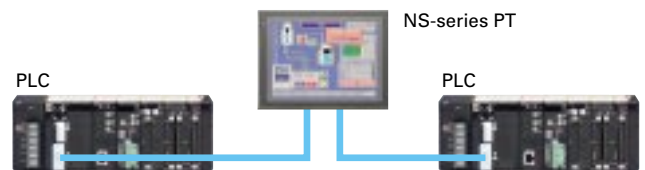

1:N NT Link

- NS:PLC ratio = 8:1 max. Up to 8 NS-series PTs can be connected to each of the PLC's RS-232C/RS-422A ports.

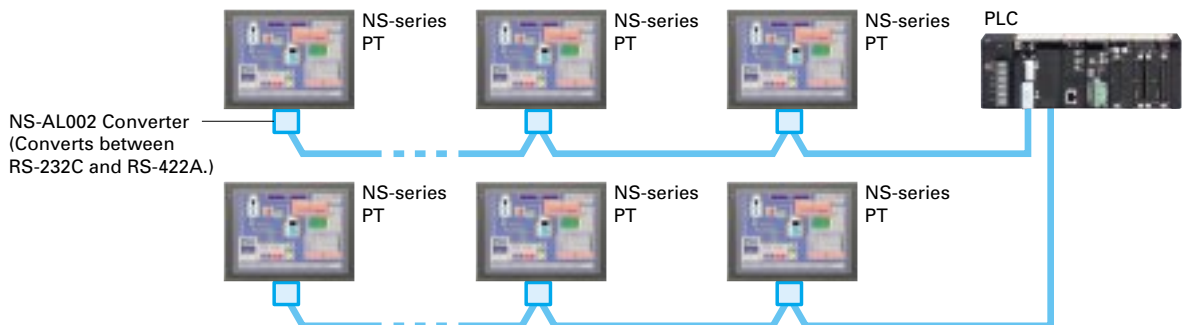

2 Controller Link Connection

The PT can be connected to an OMRON Controller Link network by mounting a Controller Link Interface Unit.

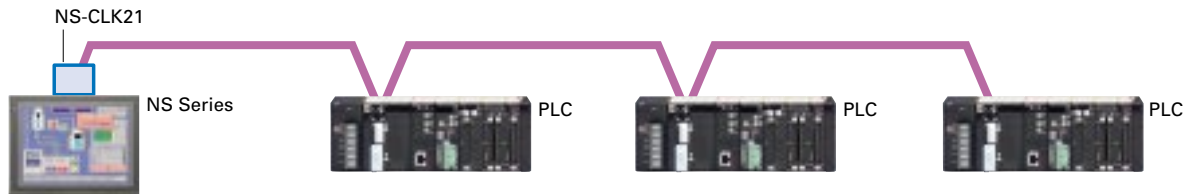

If a Controller Link connection is used, data links can be set between PLCs and multiple PLCs can be monitored/set from the NS-series PT's screen.

- Baud rate
 - 2 Mbps (500 m max.)
 - 1 Mbps (800 m max.)
 - 500 kbps (1 km max.)
- Max. number of nodes: 32 nodes

3 Ethernet Connection

If an Ethernet-compatible NS-series PT is used, the PT can connect to a PLC with an Ethernet Unit and an Option Unit is not needed to connect at the PT.

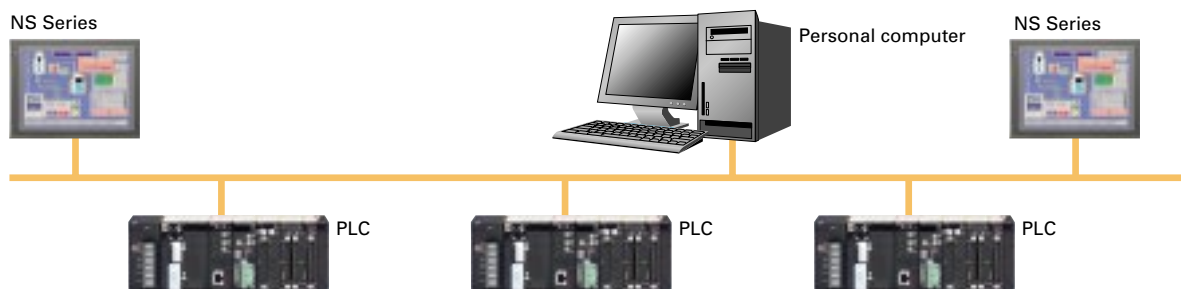

4 Connections Over Network Levels

The NS-series PTs can connect to a variety of devices in the network, through as many as 3 network levels. For example, if SAP (Smart Active Parts) are being used, an NS-series PT connected by Ethernet can be used to monitor the information in a PLC connected through Controller Link as well as the information in the DeviceNet Slaves connected to that PLC.

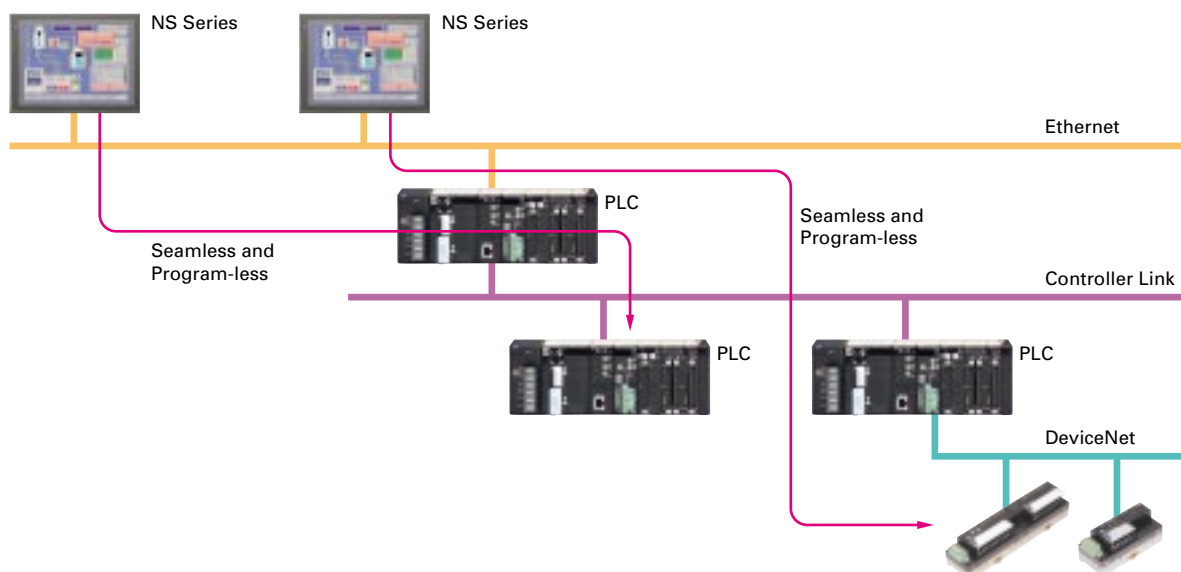

System Configuration

System Configuration Diagram

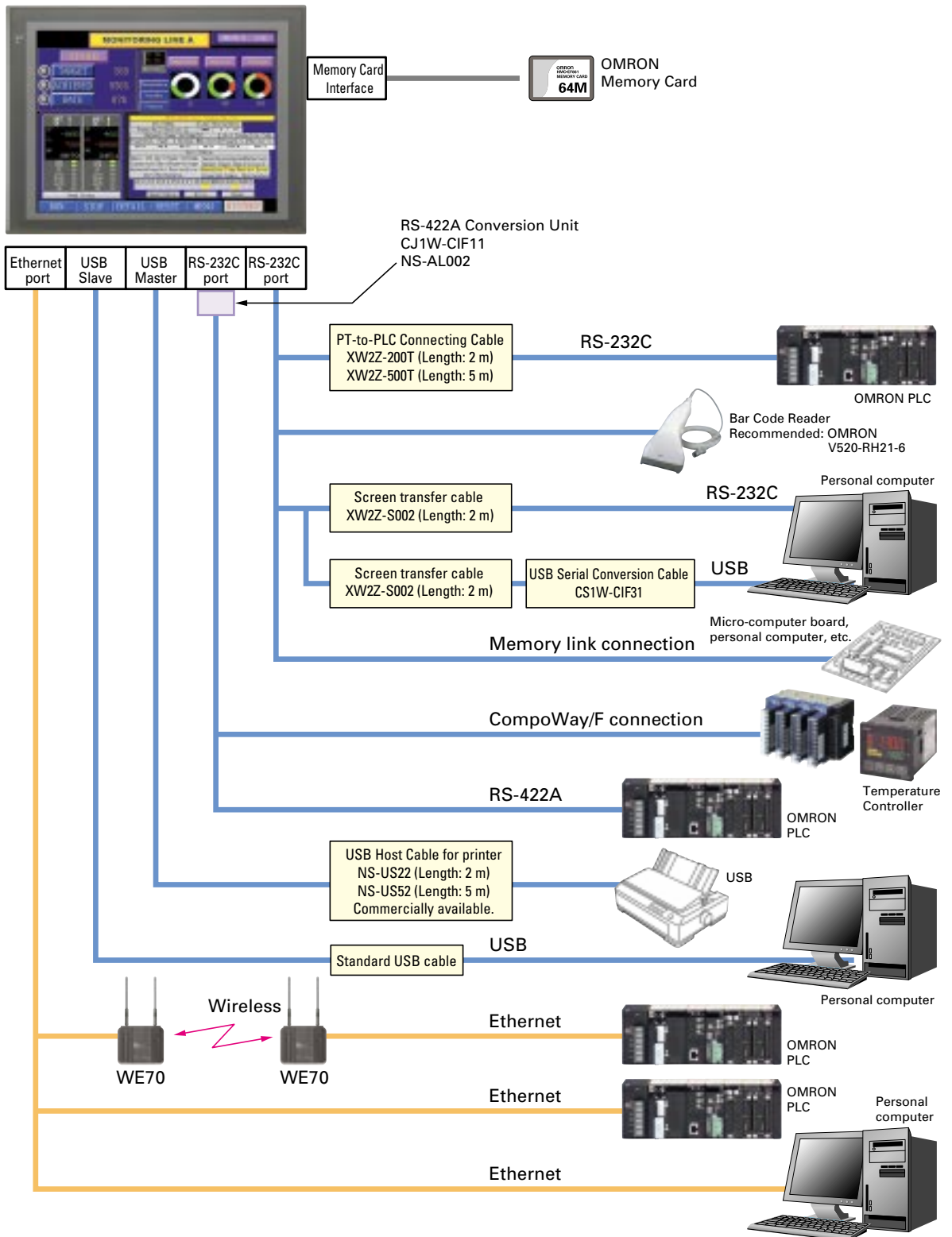

System Configuration Diagram (Expansion Bus Interface)

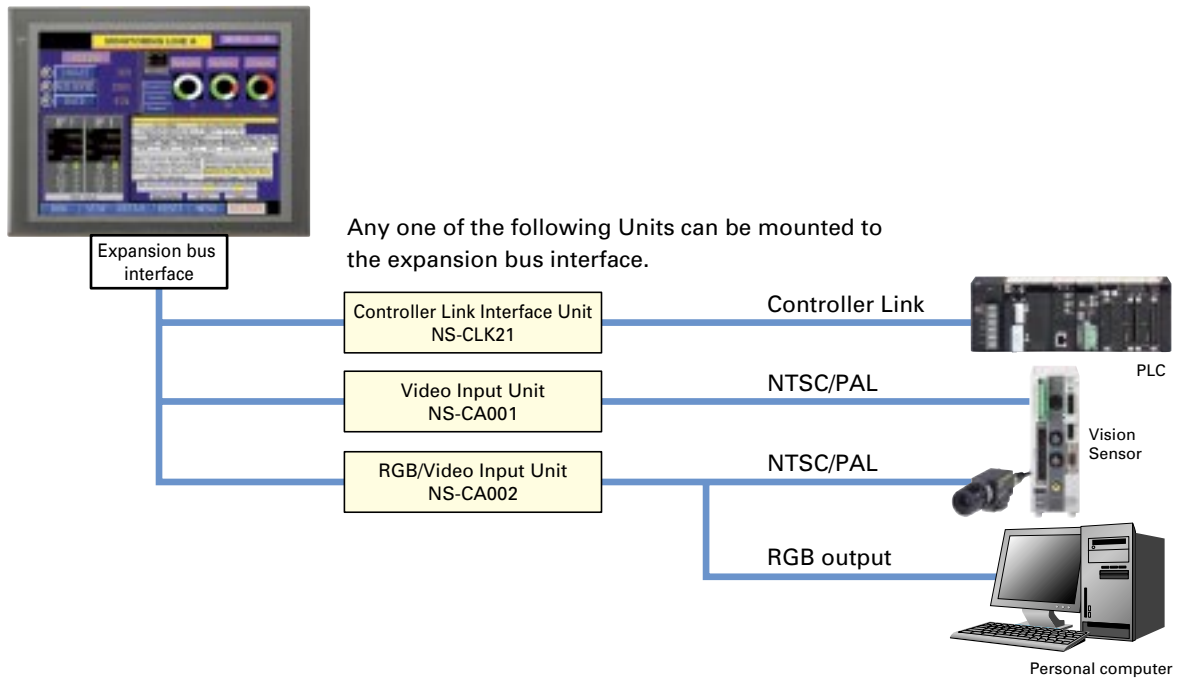

System Configuration Diagram (Multi-vendor)

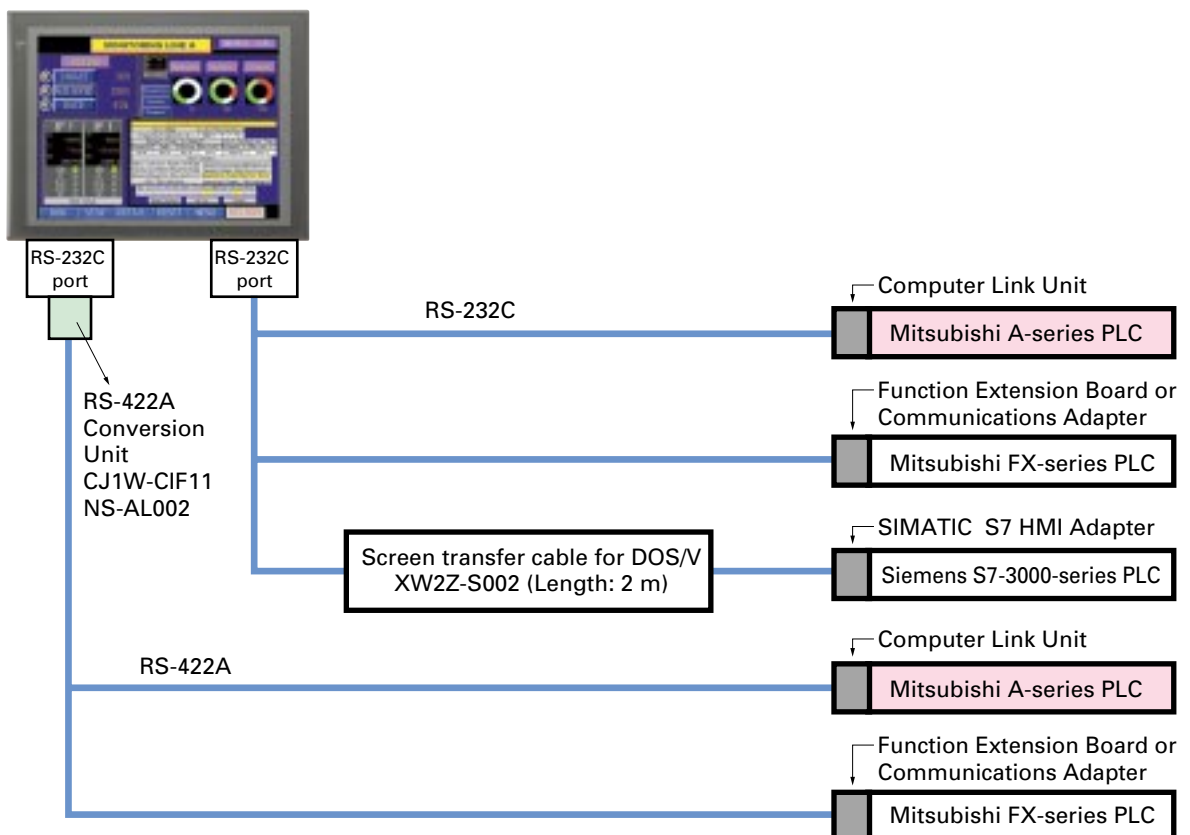

Component Names and Options

High-reliability and Advanced Functions in the Industry's Slimmest PT

Super-thin 48.5-mm Body for a Slimmer Control Panel

This thin-profile model has few protrusions so it can be incorporated easily into a panel or machine. The PT can help save space when space is at a premium.

■ NS12, NS10

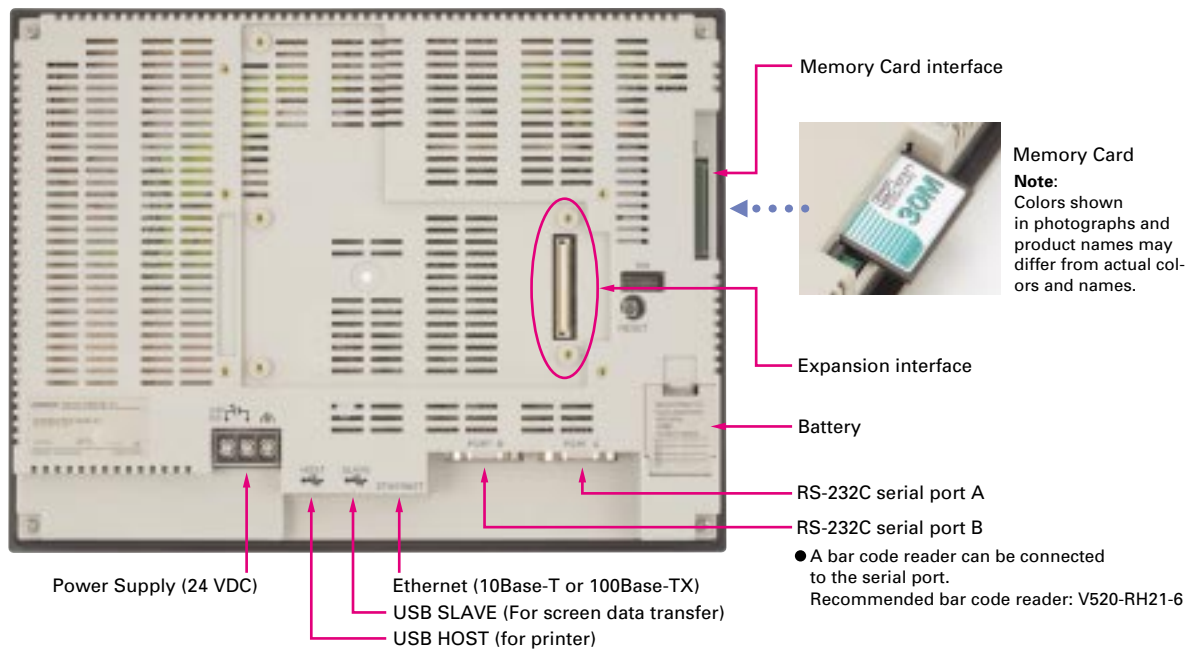

■ NS8

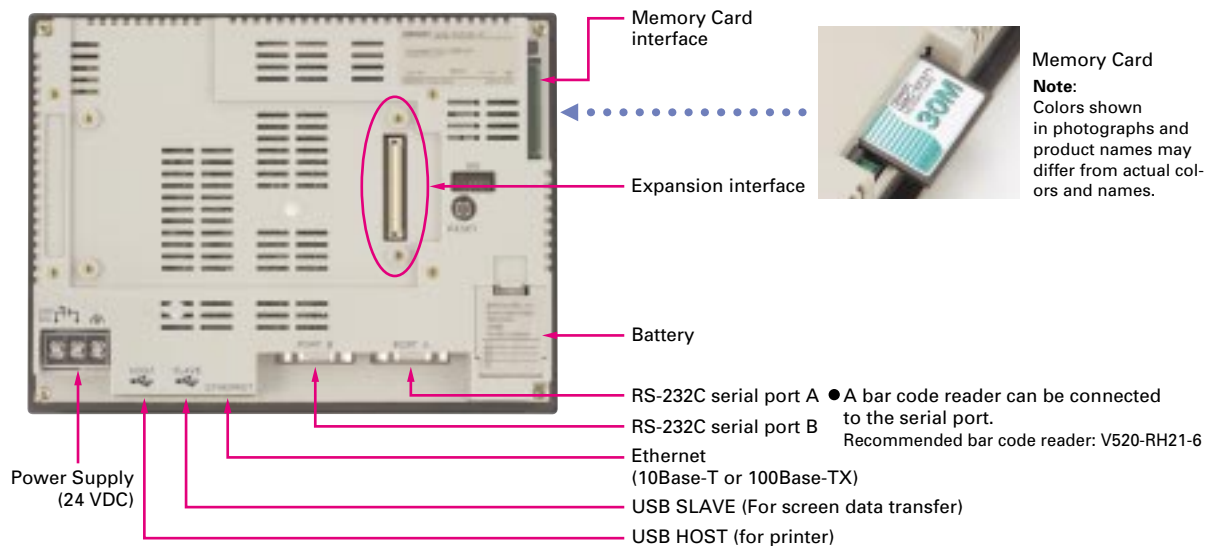

● Built-in Expansion Interface

The NS-series PTs have a built-in Expansion Interface for future expandability.

● USB Ports

A printer can be connected to the USB HOST port. Refer to *Printer Support* on page 31 for recommended printers.

■ NS5

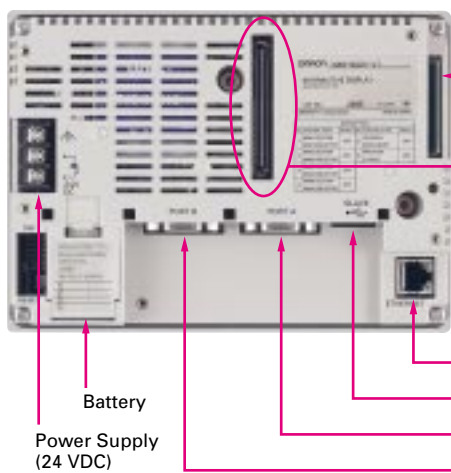

Memory Card interface



Memory Card
Note:
 Colors shown in photographs and product names may differ from actual colors and names.

Expansion interface

Ethernet (10Base-T or 100Base-TX)

USB SLAVE (For screen data transfer)

RS-232C serial port A

RS-232C serial port B

Battery
 Power Supply (24 VDC)

● A bar code reader can be connected to the serial port.
 Recommended bar code reader: V520-RH21-6

Optional Products



Video Input Unit
 NS-CA001(with Cover)



RGB/Video Input Unit
 NS-CA002 (with Cover)

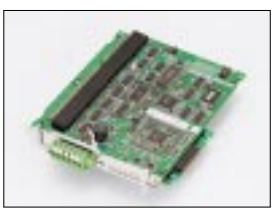

Controller Link Interface Unit
 NS-CLK21 (with Cover)

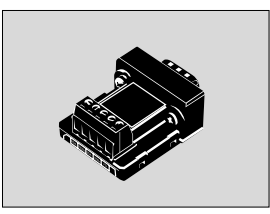

RS-422A Adapter
 CJ1W-CIF11



RS-232C/RS-422A Conversion Unit
 NS-AL002



Communications Cable
 XW2Z-S002



Protective Cover/Anti-reflection Sheet for NS-series PT
 NS□-KBA0□(N)
 NT30/NT31C-KBA05(N)



USB Serial Conversion Cable
 CS1W-CIF31

Note: Colors shown in photographs and product names may differ from actual colors and names.

NSH5 Series

A hand-held version of the NS5 is now available to perform operations at the production site. The NS-series PT's have a complete set of functions that can be used at the production site, such as the SAP Library, multi-language support, and Programming Console functions.

Function Switches
Use the ten functions switches.
F1, F2, F6, F7: Wired outputs
F3 to F5, F8 to F10: Communications outputs

Memory Card Interface and USB Slave Connector.
Easily transfer screens or save logs at high speed using a USB connection.

Emergency Stop Switch.
3PST-NC Structure
DPST-NC: Increase safety (wired outputs).
SPST-NC: Input to internal NSH5 memory, output to a lamp for emergency stop switch operation, or output via communications, e.g., to a PLC.

Water Resistance to IP65
The water-resistant structure is equivalent to IP65 on all surfaces.
Note: The PT may not be suitable for use in environments with long-term water exposure.

3-Position Enable Switch
Increased safety with DPST-NO structure (wired outputs).

Superior Shock Resistance
Consistent with JIS B 3502, IEC 61131-2 (drop shock).

PT and Cable Sold Separately
Select the Cable according to the application (RS-232C/RS-422A).
Connector-loose wires, UL connector, 3 m or 10 m.

Motor	Position Data	Motor	Position Data
PI2	111	PPK	765
PA3	231	POX	21
PHU	654	PPZ	345

● Precautions for Emergency Stop Switches

When using a hand-held NSH5 that will be installed and removed from a control panel or Removable Box, always use the specified Stop Switch (Gray/NSH5-SQG00B-V2) to conform to Safety Standards (EN 60204-1).



● Options

■ Visor

Use when the NSH5 is in direct sunlight. Installing a visor also helps protect the Emergency Stop Switch and prevents improper operation from occurring inadvertently when the PT is put down.



■ Mounting Bracket

Use to attach the NSH5 to a control panel.



System Configuration Diagram (NSH5 Hand-held PT)

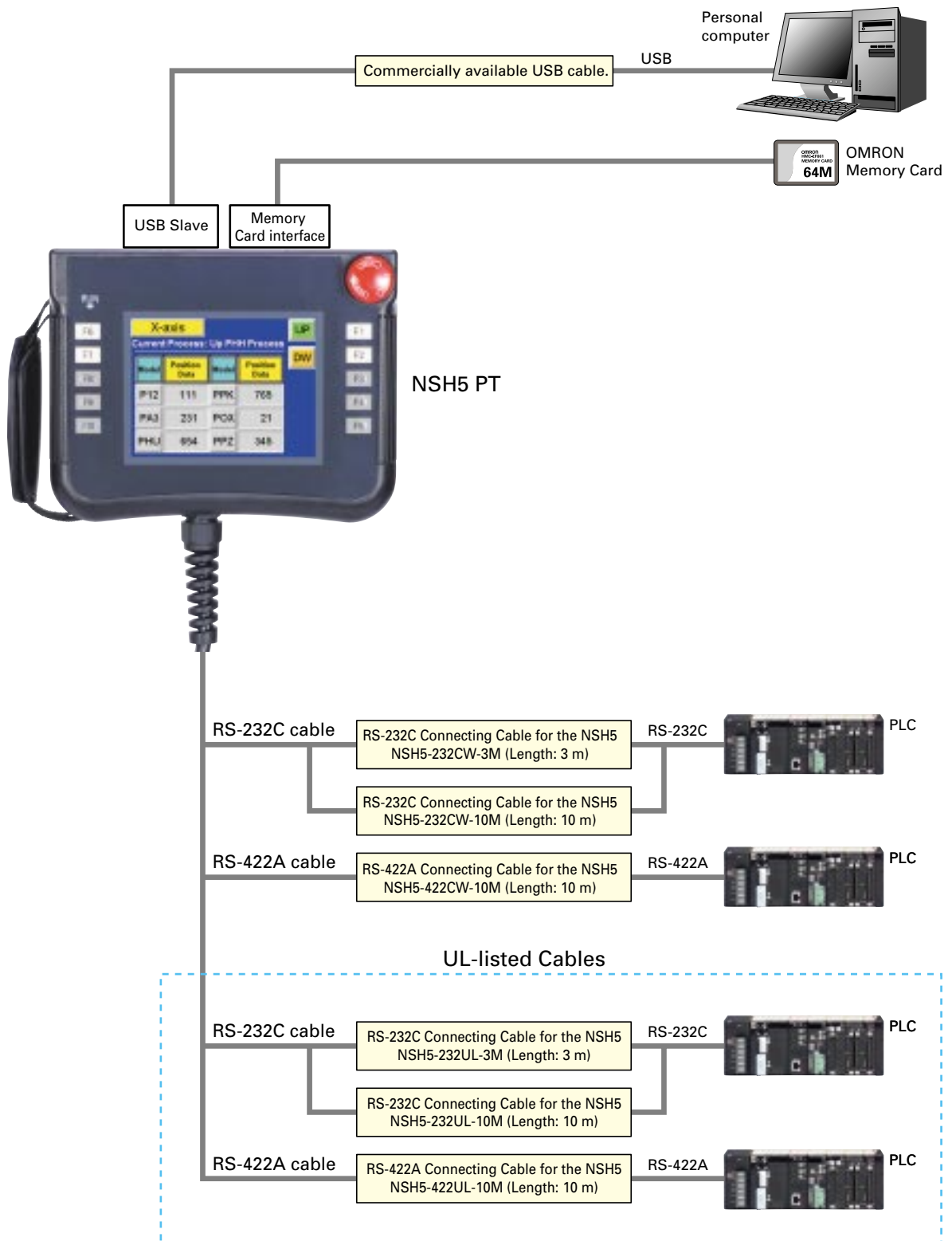

Standard Models

■ Programmable Terminals

Model name	Specifications				Model number	Standards		
	Effective display area	Number of dots	Ethernet	Case color				
NS5-V2	5.7-inch STN monochrome	320 × 240 dots	No	Ivory	NS5-MQ00-V2	CU, CE		
				Black	NS5-MQ00B-V2			
			Yes	Ivory	NS5-MQ01-V2			
				Black	NS5-MQ01B-V2			
	5.7-inch STN		No	Ivory	NS5-SQ00-V2			
				Black	NS5-SQ00B-V2			
			Yes	Ivory	NS5-SQ01-V2			
				Black	NS5-SQ01B-V2			
	5.7-inch TFT		No	Ivory	NS5-TQ00-V2			
				Black	NS5-TQ00B-V2			
			Yes	Ivory	NS5-TQ01-V2			
				Black	NS5-TQ01B-V2			
NS8-V2	8.4-inch TFT	640 × 480 dots	No	Ivory	NS8-TV00-V2	CU, CE		
				Black	NS8-TV00B-V2			
			Yes	Ivory	NS8-TV01-V2			
				Black	NS8-TV01B-V2			
NS10-V2	10.4-inch TFT	640 × 480 dots	No	Ivory	NS10-TV00-V2		CU, CE	
				Black	NS10-TV00B-V2			
			Yes	Ivory	NS10-TV01-V2			
				Black	NS10-TV01B-V2			
NS12-V2	12.1-inch TFT	800 × 600 dots	No	Ivory	NS12-TS00-V2			CU, CE
				Black	NS12-TS00B-V2			
			Yes	Ivory	NS12-TS01-V2			
				Black	NS12-TS01B-V2			
NSH5-V2 Hand-held	5.7-inch STN	320 × 240 dots	No	Black (Emergency stop button: Red)	NSH5-SQR00B-V2	CU, CE		
				Black (Stop button: Gray)	NSH5-SQG00B-V2			

■ Programming Devices





Model name	Specifications	Media	Model number	Standards	
CX-One FA Integrated Tool Package Ver. 2.0	<p>The CX-One is an integrated tool package that provides programming and monitoring software for OMRON PLCs and components.</p> <p>The CX-One runs on any of the following operating systems: OS: Windows 98 SE, Me, NT 4.0 (Service Pack 6a), 2000 (Service Pack 3 or higher), or XP. CX-Designer version 2.□ is included in CX-One version 2.0. Refer to the CX-One catalog (Cat. No. R134) for details.</p> <p>Note: Site licenses are also available for users that need to use the CX-One on many computers. Ask your OMRON representative for details.</p>	1 license	CD	CXONE-AL01C-EV2	---
			DVD	CXONE-AL01D-EV2	
		3 licenses	CD	CXONE-AL03C-EV2	
			DVD	CXONE-AL03D-EV2	
		10 licenses	CD	CXONE-AL10C-EV2	
			DVD	CXONE-AL10D-EV2	
		30 licenses	CD	CXONE-AL30C-EV2	
			DVD	CXONE-AL30D-EV2	
		50 licenses	CD	CXONE-AL50C-EV2	
			DVD	CXONE-AL50D-EV2	
The CX-Designer can also be ordered individually using the following model number.					
CX-Designer Ver.2.□	<p>Screen Designer for NS Series OS: Window 98 SE, Me, NT 4.0 (Service Pack 6a), 2000 (Service Pack 3 or higher), or XP. The Ladder Monitor Software is included with CX-Designer version 2.□.</p> <p>Note: The Ladder Monitor Software is used to monitor CS/CJ-series PLC ladder programs from an NS-series PT. A Memory Card and Memory Card Adapter (both sold separately) are required to use the Ladder Monitor Software with the NS8-V1, NS10-V1, or NS12-V1, or with the NS8-V2, NS10-V2, or NS12-V2 with system program version 6.6 or lower.</p>	1 license		NS-CXDC1-V2	---

Standard Models

Model name	Specifications	Model number	Standards	
Cable (See note.) 	Screen transfer cable for DOS/V (CX-Designer ↔ PT)	Length: 2 m	XW2Z-S002	---
	USB Host Cable (For a printer)	Length: 5 m	NS-US52	
	USB Host Cable (For a printer)	Length: 2 m	NS-US22	
	USB-Serial Conversion Cable	Length: 0.5 m	CS1W-CIF31	N
NSH5 Cables	RS-422A cable (loose wires)	Length: 10 m	NSH5-422CW-10M	---
	RS-232C cable (loose wires)	Length: 3 m	NSH5-232CW-3M	
	RS-232C cable (loose wires)	Length: 10 m	NSH5-232CW-10M	
UL-compliant NSH5 Cable	RS-422A cable (loose wires)	Length: 10 m	NSH5-422UL-10M	
	RS-232C cable (loose wires)	Length: 3 m	NSH5-232UL-3M	
	RS-232C cable (loose wires)	Length: 10 m	NSH5-232UL-10M	
PT-to-PLC Connecting Cable	PT connection: 9 pins	Length: 2 m	XW2Z-200T	---
	PLC connection: 9 pins	Length: 5 m	XW2Z-500T	
	PT connection: 9 pins PLC peripheral port	Length: 2 m	XW2Z-200T-2	
		Length: 5 m	XW2Z-500T-2	
NSH5 Wall-mounting Bracket	---		NSH5-ATT02	---
NSH5 Visor	---		NSH5-ATT01	

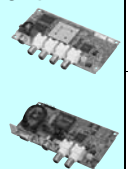
Note: Use an OMRON USB Host Cable to connect an NS-series PT to a printer.

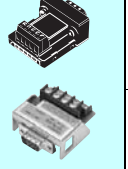
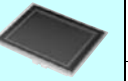

Options

Model name	Specifications	Model number	Standards	
Video Input Unit 	Inputs: 4 channels Signal type: NTSC/PAL	NS-CA001	CU, CE	
	Input channels: 2 video channels and 1 RGB channel (See note 2.) Signal type: NTSC/PAL	NS-CA002		
Special Cable for the Console	Cable length: 2 m	F150-VKP (2 m)	---	
	Cable length: 5 m	F150-VKP (5 m)		
Controller Link Interface Unit 	For Controller Link Communications	NS-CLK21	CU, CE	
RS-422A Adapter 	Transmission distance: 500 m total length Note: Use this model when connecting PT models without a V□ suffix. Note: PT models with the V□ suffix can also be connected.	NS-AL002	---	
	Transmission distance: 50 m total length Note: Only PT models with a suffix of V□ are connectable. Use the NS-AL002 to connect models without a V□ suffix.	CJ1W-CIF11	CU, N, L, CE	
Sheet/Cover (See note 2.) 	Anti-reflection Sheets (5 surface sheets)	NS12/10	NS12-KBA04	---
		NS8	NS7-KBA04	
		NS5	NT30-KBA04	
	Protective Covers (5 pack) (anti-reflection coating)	NS12/10	NS12-KBA05	
		NS8	NS7-KBA05	
		NS5	NT31C-KBA05	
Protective Covers (5 covers included) (Transparent)	NS12/10	NS12-KBA05N		
	NS8	NS7-KBA05N		
	NS5	NT31C-KBA05N		
Attachment	NT625C/631/631C Series to NS12/10 Series	NS12-ATT01	---	
	NT625C/631/631C Series to NS12/NS10 Series (Black)	NS12-ATT01B		
	NT610C Series to NS12/10 Series	NS12-ATT02		
	NT620S/620C/600S Series to NS8 Series	NS8-ATT01		
	NT600M/600G/610G/612G Series to NS8 Series	NS8-ATT02		
Memory Card 	30 MB	HMC-EF372	L, CE	
	64 MB	HMC-EF672		
	256 MB	HMC-EF283		
	512 MB	HMC-EF583		
Memory Card Adapter	---	HMC-AP001	CE	
Battery	---	CJ1W-BAT01	---	
Bar Code Reader	Refer to the Catalog for details.	V520-RH21-6	---	



Note 1. One screen cannot display two video inputs simultaneously.

2. A Chemical-resistant Cover (NT30-KBA01) is available only for the NS5.

Performance/Specifications

Series		NS5-V2												
Type		5.7-inch Monochrome STN				5.7-inch Color STN				5.7-inch Color TFT				
Appearance														
Display device		Monochrome LCD				STN color LCD				Color TFT				
Effective display area		Width 117.2 × height 88.4 mm (5.7 inches)												
Case color		Ivory		Black		Ivory		Black		Ivory		Black		
Built-in Ethernet port		No	Yes	No	Yes	No	Yes	No	Yes	No	Yes	No	Yes	
Model number		NS5-MQ00-V2	NS5-MQ01-V2	NS5-MQ00B-V2	NS5-MQ01B-V2	NS5-SQ00-V2	NS5-SQ01-V2	NS5-SQ00B-V2	NS5-SQ01B-V2	NS5-TQ00-V2	NS5-TQ01-V2	NS5-TQ00B-V2	NS5-TQ01B-V2	
Display colors		16 gradations				256 colors								
Number of dots		320 dot horizontal × 240 dot vertical												
Field of vision		Left/right: 45°, Top: 20°, Bottom: 40°				Left/right: 50°, Top: 45°, Bottom: 50°				Left/right: 70°, Top: 70°, Bottom: 50°				
Screen data capacity		20 Mbytes												
Image data (BMP or JPG images)		16 gradations				4,096 colors				32,768 colors				
Memory Card		Supported												
Ladder Monitor function		Not supported												
Video Input Unit support		Not supported												
Image displayed via video input		---												
Controller Link Interface Unit (Wired) support		Not supported												
Backlight <small>Note: Contact your nearest OMRON representative to replace the backlight.</small>	Service life	50,000 hours min.				75,000 hours min.								
	Brightness adjustment	There are 3 levels that can be set with the touch panel. Note: The brightness cannot be adjusted much.												
	Backlight error detection	Error is detected automatically, and the RUN indicator flashes green as notification. Note: This function does not indicate that the service life has been reached. It detects when the backlight is not lit due to a disconnection or other errors. Backlight error detection indicates that all backlights (2) are OFF.												
Touch panel (Matrix type)	Method	Resistive membrane												
	Number of switches	300 (20 horizontal × 15 vertical) 16 × 16 dots for each switch												
	Input	Pressure-sensitive												
	Service life	1,000,000 touch operations.												
Display text	Raster font	Displayable characters, Base size												
		Font name	Rough	Displayable characters: Alphanumeric characters or Japanese katakana, Base size: 8 × 8, Magnification: 1 × 1, 1 × 2, 2 × 1, 2 × 2, 3 × 3, 4 × 4, 8 × 8										
			Standard	Displayable characters: Alphanumeric characters or Japanese, Chinese (Simplified, Traditional) or Korean, Base size: 8 × 16, 16 × 16, Magnification: 1 × 1, 1 × 2, 2 × 1, 2 × 2, 3 × 3, 4 × 4, 8 × 8										
	Fine		Displayable characters: Alphanumeric characters or Japanese katakana, Japanese kanji, Base size: 16 × 32, 32 × 32, Magnification: 1 × 1, 1 × 2, 2 × 1, 2 × 2, 3 × 3, 4 × 4, 8 × 8											
Vector font (text objects only)	Can be specified in CX-Designer. Font, style, and size can be specified.													
Text attributes	Color	256 colors												
	Font style (only when vector font is specified)	Bold or italic												
	Vertical alignment	Top, center, or bottom												
	Horizontal alignment	Left-justified, centered, or right-justified												
Flicker	Objects supporting flicker	Functional objects: Up to 10 types can be registered. The flicker speed and flicker range can be set. Fixed objects: Select from 3 types. The flicker speed and flicker range are fixed.												
	Numeral units and scale settings	1,000 max.												

Performance/Specifications

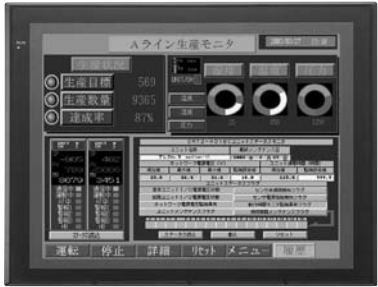
NS8-V2				NS10-V2				NS12-V2			
8.4-inch Color TFT				10.4-inch Color TFT				12.1-inch Color TFT			
											
High-definition TFT color LCD				High-definition TFT color LCD				High-definition TFT color LCD			
Width 170.9 × height 128.2 mm (8.4 inches)				Width 215.2 × height 162.4 mm (10.4 inches)				Width 246.0 × height 184.5 mm (12.1 inches)			
Ivory		Black		Ivory		Black		Ivory		Black	
No	Yes	No	Yes	No	Yes	No	Yes	No	Yes	No	Yes
NS8-TV00-V2	NS8-TV01-V2	NS8-TV00B-V2	NS8-TV01B-V2	NS10-TV00-V2	NS10-TV01-V2	NS10-TV00B-V2	NS10-TV01B-V2	NS12-TS00-V2	NS12-TS01-V2	NS12-TS00B-V2	NS12-TS01B-V2
256 colors				256 colors				256 colors			
640 dot horizontal × 480 dot vertical				640 dot horizontal × 480 dot vertical				800 dot horizontal × 600 dot vertical			
Right/left: ±65°, Top: 50°, Bottom: 60°				Right/left: ±60°, Top: 35°, Bottom: 65°				Right/left: ±60°, Top: 45°, Bottom: 75°			
60 Mbytes				60 Mbytes				60 Mbytes			
32,768 colors				32,768 colors				32,768 colors			
Supported				Supported				Supported			
Supported				Supported				Supported			
Supported				Supported				Supported			
260,000 colors				260,000 colors				260,000 colors			
Not supported				Supported				Supported			
50,000 hours min.				50,000 hours min.				50,000 hours min.			
768 (32 horizontal × 24 vertical) 20 × 20 dots for each switch				1,200 (40 horizontal × 30 vertical) 16 × 16 dots for each switch				1,900 (50 horizontal × 38 vertical) 16 × 16 dots for each switch			



Performance/Specifications

Series		NS5-V2		
Type	5.7-inch Monochrome STN		5.7-inch Color STN	5.7-inch Color TFT
Alarm/event settings		5,000 max.		
Memory Card	Interface	One ATA-Compact Flash interface slot		
	Functions	Used to transfer and store screen data, store logging data, and store history data. (Alarm/Event History, Operation Log, and Error Log generated during Macro execution).		
Expansion interface		For Expansion Interface Units		
Serial Communications	Port A	Connector	Conforms to EIA RS-232C. D-Sub female 9-pin connector 5-V output (250 mA max.) through pin 6 (See note.) Note: The 5-V outputs of serial ports A and B cannot be used at the same time.	
		Functions	Host (PLC) access: 1:N NT Links (connections with CS/CJ/CP-series PLCs and C200HX/HG/HE(-Z) PLCs), 1:1 NT Links, or Host Link (connections with C Series or CVM1/CV-series PLCs) Direct access to Temperature Controllers using Smart Active Parts: CompoWay/F and bar code reader connections (Read directly from display.)	
	Port B	Connector	Conforms to EIA RS-232C. D-Sub female 9-pin connector 5-V output (250 mA max.) through pin 6 (See note.) The 5-V outputs of serial ports A and B cannot be used at the same time. Note: The 5-V outputs of serial ports A and B cannot be used at the same time.	
		Functions	Host (PLC) access: 1:N NT Links (connections with CS/CJ/CP-series PLCs and C200HX/HG/HE(-Z) PLCs) or 1:1 NT Links (connections with C Series or CVM1/CV-series PLCs) Direct access to Temperature Controllers using Smart Active Parts: CompoWay/F and bar code reader connections (Read directly from display.)	
USB SLAVE Specifications	USB rating	USB1.1		
	Connector	TYPE-B (Slave)		
	Functions	Connection with the CX-Designer (for screen data transfers)		
USB HOST Specifications	USB rating	None		
	Connector			
	Functions			
Built-in Ethernet Specifications (NS□□□01-V2 only)	Conformance standards	Conforms to IEEE 802.3/Ethernet (10Base-T/100Base-TX).		
	Function	Host (PLC) access and connection with the CX-Designer (for screen data transfers)		
Controller Link (Wired-type) Specifications	Baud rate	---		
	Transmission path	---		
	Functions	---		
Video Input Specifications	Resolution	---		
	Input signal	---		
	Cameras	---		

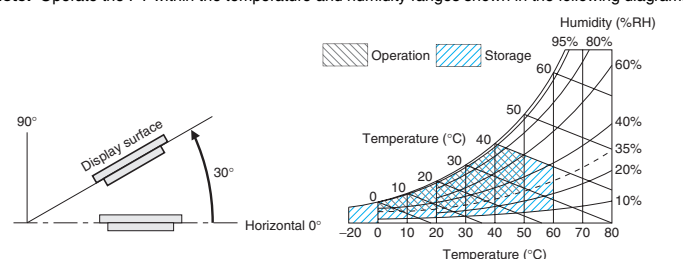
● General Specifications

Rated power supply voltage	24 VDC
Allowable voltage range	20.4 to 27.6 VDC (24 VDC \pm 15%)
Power consumption	25 W max. (15 W max. for the NS5)
Ambient operating temperature	0 to 50°C Note: The operating temperature is subject to the following restrictions according to the mounting angle. <ul style="list-style-type: none"> Mounting angle of 0 to 30° to the horizontal: Operating temperature range of 0 to 45°C When a Video Input Unit or a Controller Link Interface Unit is mounted, the ambient operating temperature is 0 to 35°C. Mounting angle of 30 to 90° to the horizontal: NS12/NS10/NS5: Operating temperature range of 0 to 50°C NS8: Mounting angle of 30° to less than 90° to the horizontal: Operating temperature range of 0 to 45°C Mounting angle of 90° to the horizontal: Operating temperature range of 0 to 50°C
Storage temperature	-20 to 60°C Note: Operate the PT within the temperature and humidity ranges shown in the following diagram. 
Ambient operating humidity	35 to 85% (0 to 40°C) 35 to 60% (40 to 50°C) (with no condensation)
Operating environment	No corrosive gases.
Noise immunity	Conforms to IEC61000-4-4, 2 kV (power lines).
Vibration resistance (during operation)	10 to 57 Hz, 0.075 mm amplitude, 57 to 150 Hz, 9.8 m/s ² 30 min each in X, Y, and Z directions
Shock resistance (during operation)	147 m/s ² 3 times each in direction of X, Y, and Z
Weight	NS5: 1.0 kg max.; NS8: 2.0 kg max.; NS10: 2.3 kg max.; NS12: 2.5 kg max.
Degree of protection	Front operating panel: Equivalent to IP65F and NEMA4. Note: May not be applicable in locations with long-term exposure to oil.
Ground	Ground to 100 Ω or less.
Battery life	5 years (at 25°C): Replace battery within 5 days after the battery runs low (indicator lights orange).
Applicable standards	cULus and EC directives

Performance/Specifications

Series	NSH5-V2	
Type	5.7-inch Color STN (Hand-held Version)	
Appearance	 <p>Emergency stop button (Red)</p>	 <p>Stop button (Gray)</p>
Case color	Black	
Built-in Ethernet port	No	
Model number	NSH5-SQROOB-V2 (Emergency stop button: Red)	NSH5-SQGOOB-V2 (Stop button: Gray)
Rated power supply voltage	24 VDC	
Allowable voltage range	20.4 to 27.6VDC (24 VDC ±15%)	
Power consumption	10 W max.	
Ambient operating temperature	0 to 40°C	
Storage temperature	-20 to 60°C	
Ambient operating humidity	35% to 85% (0 to 40°C) 35% to 60% (40 to 50°C) with no condensation	
Operating environment	No corrosive gases.	
Noise immunity	Common mode: 1,000 Vp-p (between power supply terminals and panel) Normal mode: 300 Vp-p Pulse width: 100 ns to 1 μs, Rise time: 1-ns pulse	
Vibration resistance (during operation)	10 to 57 Hz, 0.075 mm amplitude, 57 to 150 Hz, 9.8 m/s ² 30 min each in X, Y, and Z directions	
Shock resistance (during operation)	147 m/s ² 3 times each in direction of X, Y, and Z	
Weight	1 kg max.	
Degree of protection	Equivalent to IP65.	
Ground	Ground to 100 Ω or less.	
Battery life	5 years (at 25°C): Replace battery within 5 days after the battery runs low (indicator lights orange).	
Applicable standards	cULus and EC directives Conforms to EN60204-1.	

Compatible OMRON PLCs

Link Connection

PLC series	PLC model name	Model number	Specifications
C Series	CQM1	CQM1-CPU□□-V1	With RS-232C connector (9-pin type)
	CQM1H	CQM1H-CPU□□	
	CPM1	CPM1-□□CDR-□+CPM1-CIF01	Connect to peripheral port.
	CPM1A	CPM1A-□□CD□-□+CPM1-CIF01	
	CPM2A	CPM2A-□□CD□□-□+CPM1-CIF01	Connect to RS-232C or peripheral port.
	CPM2C	CPM2C-10/20□□□□□□-□ (See note 1.)	With RS-232C connector (9-pin type)
	C200HS	C200HS-CPU□□	
	C200HE(-Z)	C200HE-CPU□□(-Z) (See note 2.)	
	C200HG(-Z)	C200HG-CPU□□(-Z) (See note 2.)	
C200HX(-Z)	C200HX-CPU□□(-Z) (See note 2.)		
CVM1/CV Series	CV500/1000/2000	CV500/1000/2000-CPU□□-V1	With RS-232C connector (switching/9-pin type)
	CVM1	CVM1-CPU□□-V2	

Note 1. Use an Adapter Cable (CPM2C-CN111 or CS1W-CN114/118), CPM1-CIF01 RS-232C Adapter, or CPM1-CIF11 RS-422A Adapter to connect.
2. A C200HW-COM02(-V1), C200HW-COM04(-V1), C200HW-COM05(-V1), or C200HW-COM06(-V1) Communications Board is required.

1:N NT Link Connection

PLC series	PLC model name	Model number	Specifications
CS series	CS1G	CS1G-CPU□□(-V1) (See note 1.)	With RS-232C connector (9-pin type)
		CS1G-CPU□□H (See note 1.)	
	CS1H	CS1H-CPU□□(-V1) (See note 1.)	
		CS1H-CPU63H/CPU64H/CPU65H/CPU66H/CPU67H (See note 1.)	
CS1D	CS1D-CPU□□H (See note 1.)		
CJ series	CJ1G	CJ1G-CPU□□H (See note 2.)	With RS-232C connector (9-pin type)
	Loop-control CPU Unit	CJ1G-CPU□□P	
	CJ1H	CJ1H-CPU□□H (See note 2.)	
CJ1M	CJ1M-CPU□□ (See note 2.)		
CP series	CP1H	CP1H-□□	Connect to the RS-232C connector of a CP1W-CIF01 RS-232C Option Board.
C series	CQM1H	CQM1H-CPU61/51 with a CQM1H-SCB41 Serial Communications Board	With RS-232C connector (9-pin type)
	C200HE(-Z)	C200HE-CPU32(-Z) (See note 3.)/CPU42(-Z)	
	C200HG(-Z)	C200HG-CPU33(-Z) (See note 3.)/CPU43(-Z)/CPU53(-Z) (See note 3.)/CPU63(-Z)	
	C200HX(-Z)	C200HX-CPU34(-Z) (See note 3.)/CPU44(-Z)/CPU54(-Z) (See note 3.)/CPU64(-Z)/CPU65-Z/CPU85-Z	

Note 1. Connection is also possible to a CS1W-SCB□□-V1 Serial Communications Board or CS1W-SCU□□-V1 Serial Communications Unit.
2. Connection is also possible to the CJ1W-BCU□□-V1 Serial Communications Unit.
3. A C200HW-COM02/COM04/COM05/COM06(-V1) Communications Board is required.

Connecting by Host Link

PLC series	PLC model name	Model number	Specifications
C series	CPM1	CPM1-□□CDR-□/CPM1A-□□CD□-□	RS-232C or RS-422A adapter connected to peripheral port
	CPM2A	CPM2A-□□CD□□-□	With RS-232C connector (9-pin type)
	CPM2C	CPM2C-10/20□□□□□□-□	Communications connectors include both a peripheral port and RS-232C port (branching possible through CPM2C-CN111 Conversion Cable). Used as separate peripheral and RS-232C ports through CS1WCN114/118 Conversion Cable.
	CQM1	CQM1-CPU□□-V1	With RS-232C connector (9-pin type)
	CQM1H	CQM1H-CPU□□	With RS-232C connector (9-pin type) (CQM1H-CPU11: peripheral port only)
	C200HS	C200HS-CPU□□	With RS-232C connector (switching/9-pin type)
	C200HE(-Z)	C200HE-CPU□□(-Z) (See note 1.)	
	C200HG(-Z)	C200HG-CPU□□(-Z) (See note 1.)	
	C200HX(-Z)	C200HX-CPU34 (-Z) (See note 1.)/CPU44 (-Z)/CPU54 (-Z) (See note 1.)/CPU64 (-Z)/CPU65-Z/CPU85-Z	
CS series	CS1G	CS1G-CPU□□(-V1) (See note 2.)	With RS-232C connector (9-pin type)
		CS1G-CPU□□H (See note 2.)	
	CS1H	CS1H-CPU□□(-V1) (See note 2.)	
CJ series	CJ1G	CJ1G-CPU□□H (See note 3.)	With RS-232C connector (9-pin type)
	Loop-control CPU Unit	CJ1G-CPU□□P	
	CJ1H	CJ1H-CPU□□H (See note 3.)	
	CJ1M	CJ1M-CPU□□ (See note 3.)	
CVM1/CV series	CV500/1000/2000	CV500-CPU01-V1/CV1000-CPU01-V1/CV2000-CPU01-V1	With RS-232C connector (switching/9-pin type)
	CVM1	CVM1-CPU□□-V2	

Note 1: A C200HW-COM02/COM04/COM05/COM06(-V1) Communications Board is required.
2: Connection is also possible to a CS1W-SCB□□-V1 Serial Communications Board or CS1W-SCU□□-V1 Serial Communications Unit.
3: Connection is also possible to the CJ1W-BCU□□-V1 Serial Communications Unit.

Connectable PLCs

● Connecting to Another Company's PLC

PLC series	CPU Unit	SIMATIC S7 HMI Adapter
Siemens S7-300 Series	CPU313 CPU315-2DP CPU317-2PN/DP	6ES7 972-0CAI□-0XA0

PLC series	CPU Unit	Computer Link Unit
Mitsubishi Electric Corporation, A Series	A1SHCPU A2USHCPU-S1 A2US	AISJ71UC24-R2 AISJ71UC24-R4

PLC series	Basic Unit	Communications Adapter	Function Extension Board
Mitsubishi Electric Corporation, FX Series	FX0N FX1S FX1N FX1NC FX2N FX3UC	FX□□(□)-232ADP FX□□(□)-485ADP	FX□□-232-BD FX□□-485-BD FX□□-422-BD

Connectable Temperature Controllers

■ Compatible Temperature Controllers (Support Direct Connection)

The following Temperature Controllers can be connected directly to an NS-series PT.

Unit name	Series	Model	Remarks
Modular Temperature Controller	EJ1	EJ1-EDU End Unit	SAP screens are available.
Modular Temperature Controller	E5ZN	E5ZN-SCT24S Terminal Unit	
Digital Controller	E5AR	E5AR-□□□□□□□□□□-FLK	
	E5ER	E5ER-□□□□□□□□□□-FLK	
Digital Temperature Controller	E5CN	E5CN-□□M□-500/E5CN-□□□U+ Option Unit with Communications required.	
	E5AN/E5EN	E5AN-□□□M□-500/E5EN-□□□M□-500 Option Unit with Communications required.	
	E5GN	E5GN-□□□TC-FLK Thermocouple Input Type	
E5GN-□□□P-FLK Platinum Resistance Thermometer Input Type			

Connection Configurations

■ Transferring Screens (Connecting the CX-Designer and PT)

● Connecting to the Computer's RS-232C Port

Use a XW2Z-S002 Cable for screen transfers.

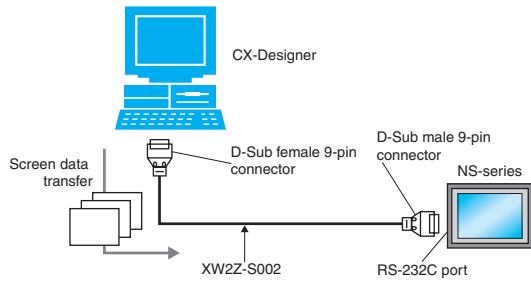

● Connecting to the Computer's USB Port

Use a CS1W-CIF31 USB-Serial Conversion Cable and XW2Z-S002 Cable for screen transfers.

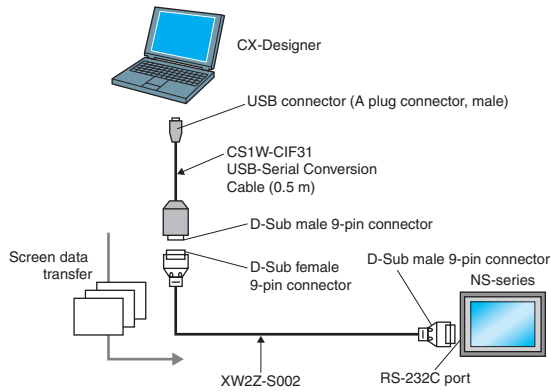

A standard USB cable can be used when connecting the CX-Designer to an NS-series with lot number 0325 (February 3, 2005) or later.

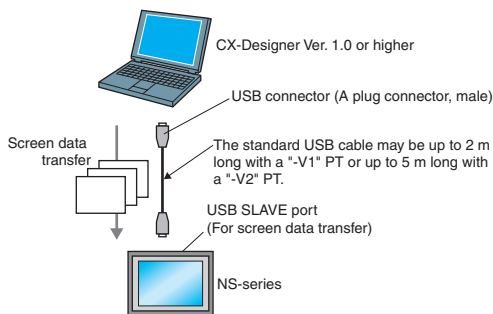

● Connecting to the Computer's LAN (Ethernet) Port

Connecting Directly (1:1) to the Computer

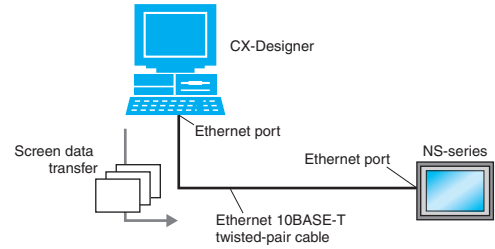

Connecting to the Computer through a Hub

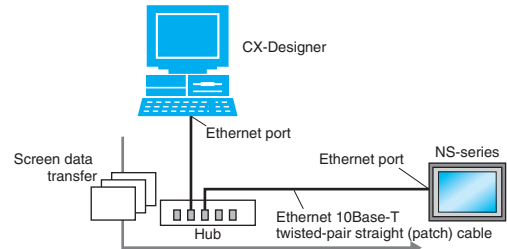

Note: An NS-series PT can also connect to a network configured for 10Base-5 when using a hub and transceiver set for 10Base-5 communications.

● Connecting through a PLC

If the PLC is a CS/CJ-series PLC and its CPU Unit has lot number 030201 or later, screen data can be transferred to an NS-series PT through the PLC.

Using a Serial → Serial Connection

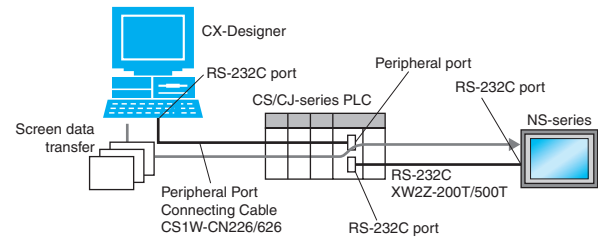

Using an Ethernet → Serial Connection

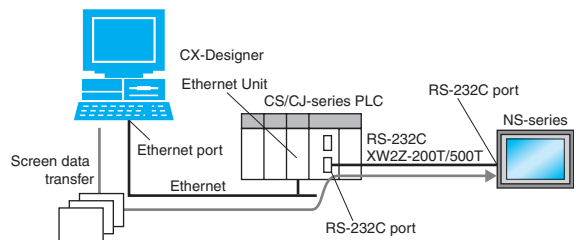

Connection Configurations

■ Operation (Connection between NS-series PT and PLC)

● Using a Serial Connection

When connecting to a CS/CJ-series PLC's RS-232C port, use an XW2Z-200T/500T Cable between the PT and PLC.

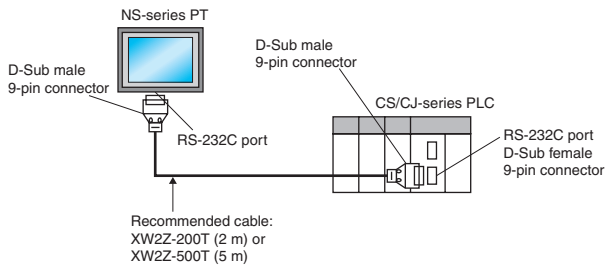

When connecting to a CS/CJ-series PLC's peripheral port, use an XW2Z-200T-2/500T-2 Cable between the PT and PLC.

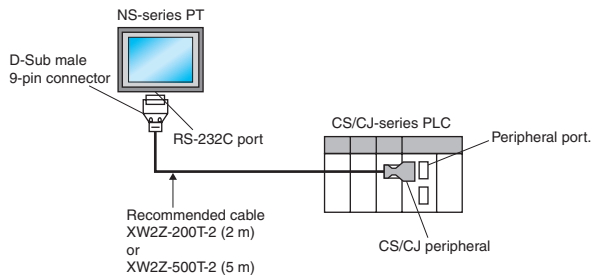

● Using an Ethernet Connection

Connecting Directly (1:1) to the Computer

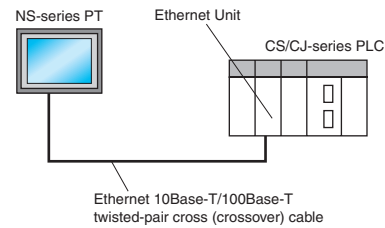

Connecting to the Computer via a Hub

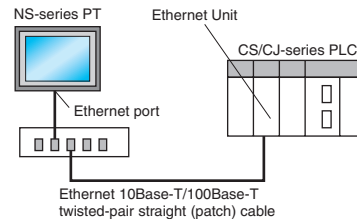

Note: An NS-series PT can also connect to a network configured for 10Base-5 when using a hub and transceiver set for 10Base-5 communications.

In addition, the NS-series PT can be connected through Controller Link by mounting an NS-CLK21 Controller Link Interface Unit to the PT.

Smart Active Parts (SAP) Library Contents

The following Smart Active Parts are provided on the CX-One/CX-Designer.

● For CS/CJ CPU Unit

Error Log Monitor, Online Battery Change Button, etc.

● For Serial Communications Boards/Units

Communications Status Displays (Error Monitor), Ports Settings, etc.

● For Ethernet Units/CLK Units

Network Status Displays (Error Monitor and Network Node Status), etc.

● For MC/MCH Unit

JOG Running, Search Zero Position, Program Running, Error Displays, I/O Status Monitor, PV Monitor, etc.

● For NC/NCF Unit

JOG Running, Direct Running, Memory Running (NC Only), Error Displays I/O Status Monitor, PV Monitor, etc.

● For Wireless Terminals for WT30

Monitoring Slave Operating Status in a Wireless Environment

● For Servo (R88D-WT, R7D-AP) (See note.)

PV Monitor, Parameter Settings, Error Displays, Driver Information Displays, I/O Status Monitor, etc.

● For Inverters (See note.)

Rotation Speed/Monitoring Output Frequency, Other Parameter Settings, etc.

● For DeviceNet

DRT2 Maintenance/Status Information, IN/OUT Information, etc.

● For Temperature Controllers (E5□R, E5ZN, E5□N, EJ1 and CJ1W-TC)

Operation Monitor, PID Settings, SP Settings, Alarm Settings, Input Shift Settings, etc.

● For Sensors (E3X-DRT)

Threshold Settings, Monitoring Light Reception Levels, etc.

● For the SmartSlice GRT1 Series

Communications Unit Status, Warning/Alarm Flags, Network Joining/Leaving Status

Note: Smart Active Parts require a Serial Communications Units/Boards (version 1.2 or later).

Dimensions

(Units: mm)

NS12/10

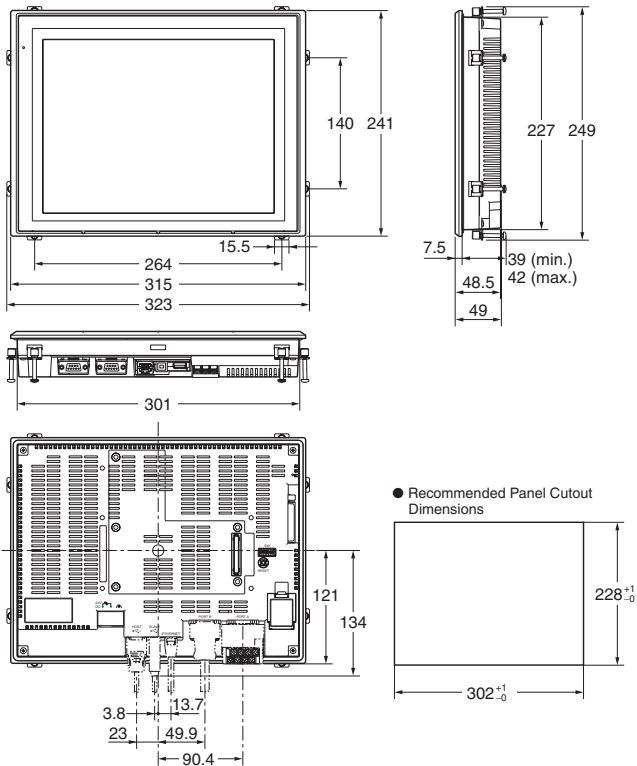

NS8

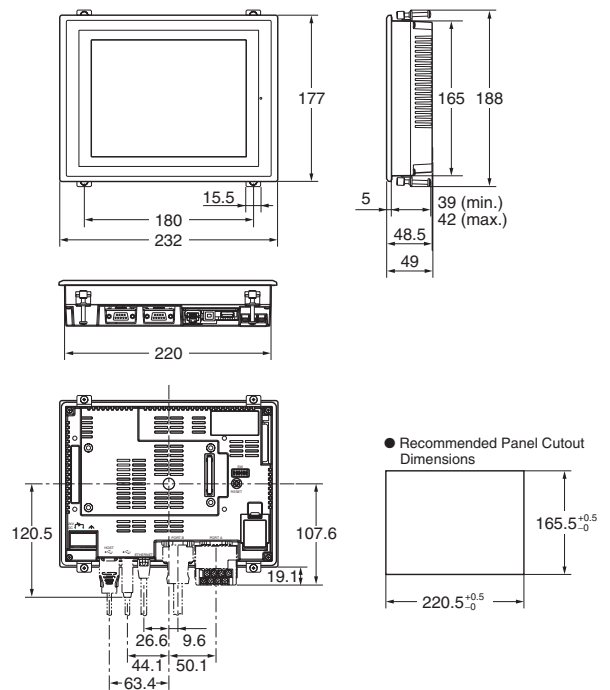

NS5

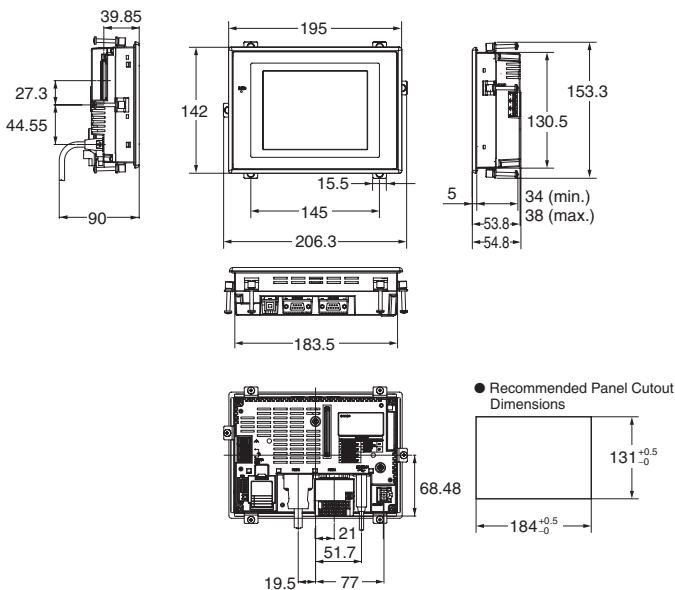

Hand-held NS5

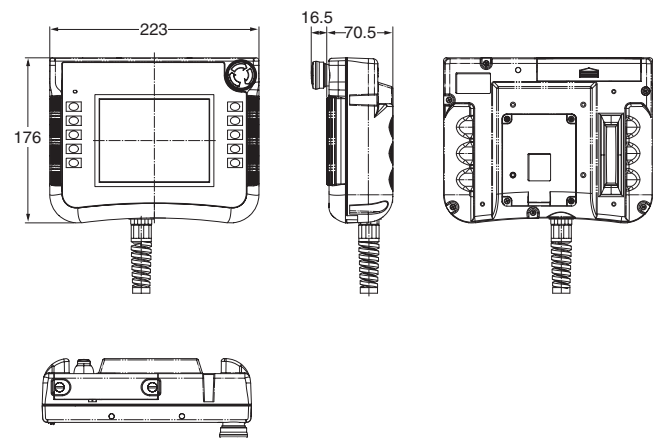

NS-CA001

Video Input Unit

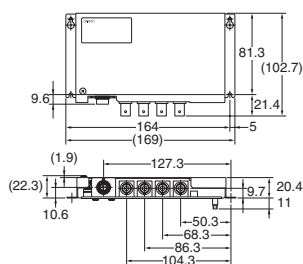

NS-CA002

Video Input Unit

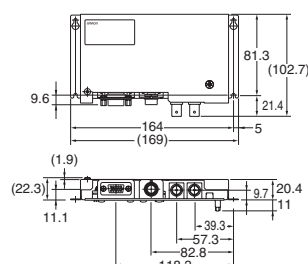

NS-CLK21

Controller Link Interface Unit

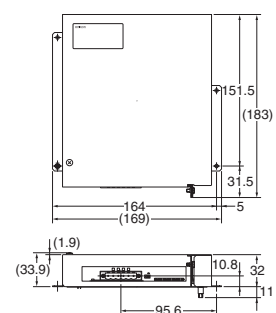

Ordering Information

● International Standards

- The standards indicated in the "Standards" column are those current for UL, CSA, cULus, cUL, NK, and Lloyd standards and EC Directives as of the end of November 2006. The standards are abbreviated as follows: U: UL: U1: UL (Class 1 Division 2 Product for Hazardous Locations), C: CSA, UC: cULus, UC1: cULus (Class 1 Division 2 Product for Hazardous Locations), CU: cUL, N: NK, L: Lloyd, CE: EC Directives.
- Ask your OMRON representatives for the conditions under which the standards were met.

● EC Directives

The EC Directives applicable to PLCs include the EMC Directives and the Low Voltage Directive. OMRON complies with these directives as described below.

● EMC Directives

Applicable Standards (See note.) EMI: EN61131-2
EN61000-6-4
EMS: EN61131-2
EN61000-6-2

PLCs are electrical devices that are incorporated in machines and manufacturing installations. OMRON PLCs conform to the related EMC standards so that the devices and machines into which they are built can more easily conform to EMC standards. The actual PLCs have been checked to conformity to EMC standards. Whether these standards are satisfied for the actual system, however, must be checked by the customer.

EMS-related performance will vary depending on the configuration, wiring, and other conditions of the equipment or control panel in which the PLC is installed. The customer must, therefore, perform final checks to confirm that the overall machine or device conforms to EMC standards.

Note: The applicable EMS standards depends on the product.

● Low Voltage Directive

PLC Applicable Standard: EN61131-2

Devices that operate at voltage from 50 to 1,000 VAC or 75 to 150 VDC must satisfy the appropriate safety requirements. With PLCs, this applies to Power Supply Units and I/O Units that operate in these voltage ranges.

These Units have been designed to conform to EN61131-2, which is the applicable standards for PLCs.

Read and Understand this Catalog

Please read and understand this catalog before purchasing the product. Please consult your OMRON representative if you have any questions or comments.

Warranty and Limitations of Liability

WARRANTY

OMRON's exclusive warranty is that the products are free from defects in materials and workmanship for a period of one year (or other period if specified) from date of sale by OMRON.

OMRON MAKES NO WARRANTY OR REPRESENTATION, EXPRESS OR IMPLIED, REGARDING NON-INFRINGEMENT, MERCHANTABILITY, OR FITNESS FOR PARTICULAR PURPOSE OF THE PRODUCTS. ANY BUYER OR USER ACKNOWLEDGES THAT THE BUYER OR USER ALONE HAS DETERMINED THAT THE PRODUCTS WILL SUITABLY MEET THE REQUIREMENTS OF THEIR INTENDED USE. OMRON DISCLAIMS ALL OTHER WARRANTIES, EXPRESS OR IMPLIED.

LIMITATIONS OF LIABILITY

OMRON SHALL NOT BE RESPONSIBLE FOR SPECIAL, INDIRECT, OR CONSEQUENTIAL DAMAGES, LOSS OF PROFITS OR COMMERCIAL LOSS IN ANY WAY CONNECTED WITH THE PRODUCTS, WHETHER SUCH CLAIM IS BASED ON CONTRACT, WARRANTY, NEGLIGENCE, OR STRICT LIABILITY.

In no event shall the responsibility of OMRON for any act exceed the individual price of the product on which liability is asserted.

IN NO EVENT SHALL OMRON BE RESPONSIBLE FOR WARRANTY, REPAIR, OR OTHER CLAIMS REGARDING THE PRODUCTS UNLESS OMRON'S ANALYSIS CONFIRMS THAT THE PRODUCTS WERE PROPERLY HANDLED, STORED, INSTALLED, AND MAINTAINED AND NOT SUBJECT TO CONTAMINATION, ABUSE, MISUSE, OR INAPPROPRIATE MODIFICATION OR REPAIR.

Application Considerations

SUITABILITY FOR USE

OMRON shall not be responsible for conformity with any standards, codes, or regulations that apply to the combination of the product in the customer's application or use of the product.

Take all necessary steps to determine the suitability of the product for the systems, machines, and equipment with which it will be used.

Know and observe all prohibitions of use applicable to this product.

NEVER USE THE PRODUCT FOR AN APPLICATION INVOLVING SERIOUS RISK TO LIFE OR PROPERTY WITHOUT ENSURING THAT THE SYSTEM AS A WHOLE HAS BEEN DESIGNED TO ADDRESS THE RISKS, AND THAT THE OMRON PRODUCT IS PROPERLY RATED AND INSTALLED FOR THE INTENDED USE WITHIN THE OVERALL EQUIPMENT OR SYSTEM.

PROGRAMMABLE PRODUCTS

OMRON shall not be responsible for the user's programming of a programmable product, or any consequence thereof.

Disclaimers

CHANGE IN SPECIFICATIONS

Product specifications and accessories may be changed at any time based on improvements and other reasons. Consult with your OMRON representative at any time to confirm actual specifications of purchased product.

DIMENSIONS AND WEIGHTS

Dimensions and weights are nominal and are not to be used for manufacturing purposes, even when tolerances are shown.

PERFORMANCE DATA

Performance data given in this catalog is provided as a guide for the user in determining suitability and does not constitute a warranty. It may represent the result of OMRON's test conditions, and the users must correlate it to actual application requirements. Actual performance is subject to the OMRON Warranty and Limitations of Liability.

Note: Do not use this document to operate the Unit.

Printed on 100%
Recycled Paper



OMRON Corporation
Industrial Automation Company
Control Devices Division H.Q.
Shiokoji Horikawa, Shimogyo-ku,
Kyoto, 600-8530 Japan
Tel: (81)75-344-7109
Fax: (81)75-344-7149

Regional Headquarters

OMRON EUROPE B.V.
Wegalaan 67-69, NL-2132 JD Hoofddorp
The Netherlands
Tel: (31)2356-81-300/
Fax: (31)2356-81-388

OMRON ELECTRONICS LLC
1 East Commerce Drive, Schaumburg,
IL 60173 U.S.A.
Tel: (1)847-843-7900/Fax: (1)847-843-8568

OMRON ASIA PACIFIC PTE. LTD.
83 Clemenceau Avenue,
#11-01, UE Square,
Singapore 239920
Tel: (65)6835-3011/Fax: (65)6835-2711

OMRON (CHINA) CO., LTD.
Room 2211, Bank of China Tower,
200 Yin Cheng Zhong Road,
PuDong New Area, Shanghai, 200120 China
Tel: (86)21-5037-2222/Fax: (86)21-5037-2200

Authorized Distributor:

Note: Specifications subject to change without notice.

Cat. No. V405-E1-01
Printed in Japan
1206-1M

