

RoLin™ miniature packaged incremental magnetic encoder sensor system



RoLin™ is a component level encoder consisting of a RoLin readhead and a magnetic scale or a ring. It has been designed for embedded motion control applications as a position control loop feedback element.

The information carrier is a periodically magnetised scale with a pole length of 2 mm. Radial or axial reading of the ring is possible.

State of the art position sensing assures highly repeatable position measurement under wide installation tolerances and temperature ranges.

Position information is output in incremental quadrature and parallel, SSI or BiSS format with the option



of a periodic reference mark (every pole). When SSI or BiSS communication protocol is selected the value of internal period counter (1 pole = 1 period) can be output. 8 bit, 12 bit or 24 bit counter lengths can be selected. Optionally, period counter can be reset when traversing the reference mark (if selected).

Maximum speed depends on the chosen resolution and minimum edge separation time; eg. for linear applications to 7 m/s at 1 µm and to 75 m/s at 10 µm. For more information about maximum speed in rotary applications go to [magnetic ring data sheet](#).

A self-diagnosis feature enables the sub-system to diagnose potential failures of the encoder which are signalled on the Error line using a PWM formatted code.

- Incremental ABZ, TTL or RS422 logic level
- SSI or BiSS, TTL logic level
- High speed operation
- Bi-directional reference mark
- High reliability from proven non-contact sensing technology
- Pin / Flex cable options
- Self-diagnosis feature
- CE compliant, including RoHS - see Declaration of conformity

Readhead selection guide

	RoLin with pins	RoLin with flex cable	RoLin with RS422 flex cable
			
Fixing of readhead	By soldering	Mounting bracket	Mounting bracket
Connection to system PCB	Direct soldering to PCB	With flex cable and zif connector	With flex cable and zif connector
Available flex cable output lengths	-	75 mm	136 mm
Overall distance to subsequent device	Distance depends on loading characteristics and edge separation time; generally: < 300 mm	Distance depends on loading characteristics and edge separation time; generally: < 300 mm	> 50 m (with FPC and extension cables)
Output type	SSI, BiSS-C and Incremental, no line driver (A, B, Z)	SSI, BiSS-C and Incremental, no line driver (A, B, Z)	Incremental, RS422 line driver (A, B, Z, A-, B-, Z-)
Error signal	Available	Available	Not available
EMC	Should be assured by system's housing and sub-system's circuitry	Should be assured by system's housing and sub-system's circuitry	Enhanced but should still be assured by system's housing and sub-system's circuitry

Storage and handling

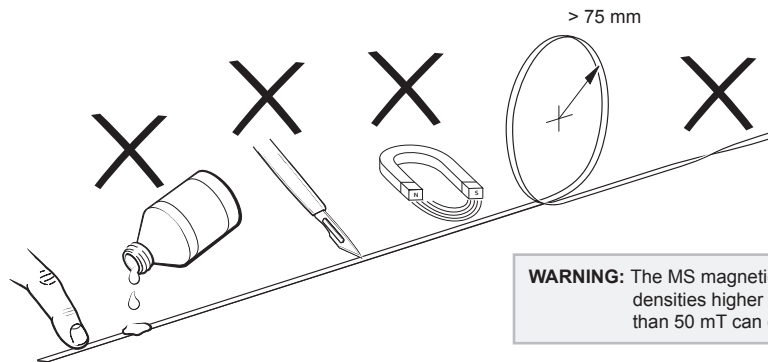

WARNING: The MS magnetic scale should not be exposed to magnetic field densities higher than 50 mT on its surface. Magnetic fields higher than 50 mT can damage the scale.

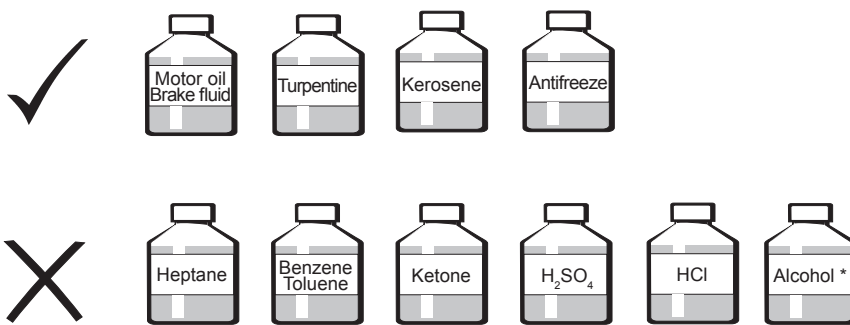

* Use of alcohol for cleaning is considered safe, however, it is not allowed to immerse the scale in alcohol.



For radial and axial ring storage and handling refer to [magnetic ring data sheet](#).

RoLin readhead with pins for direct soldering to PCB

Dimensions and tolerances are in mm.

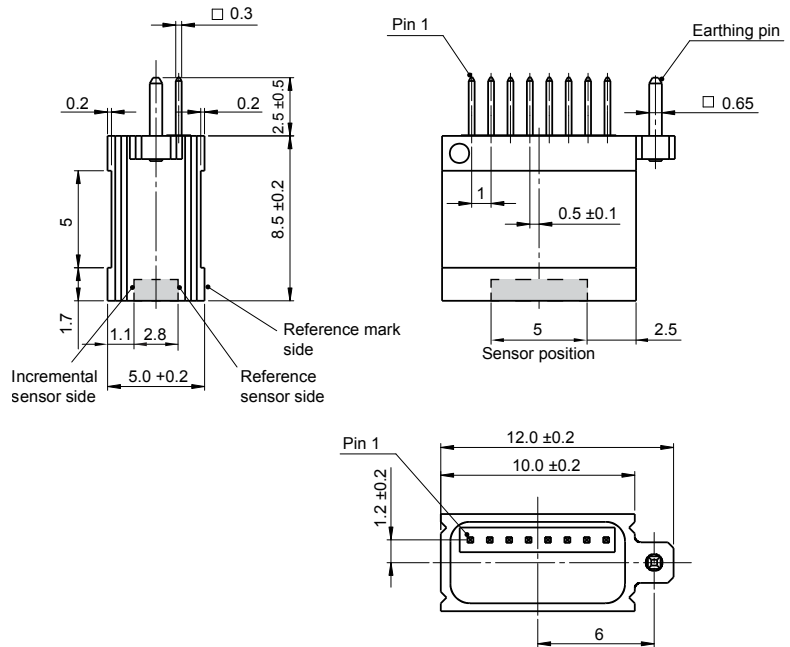

Pinout

Pin	Signal	Function
1	SLO	Output
2	MA	Input
3	Error	Output
4	V _{dd} (+5 V)	Power
5	GND (0 V)	Power
6	A	Output
7	Z	Output
8	B	Output

PCB footprint

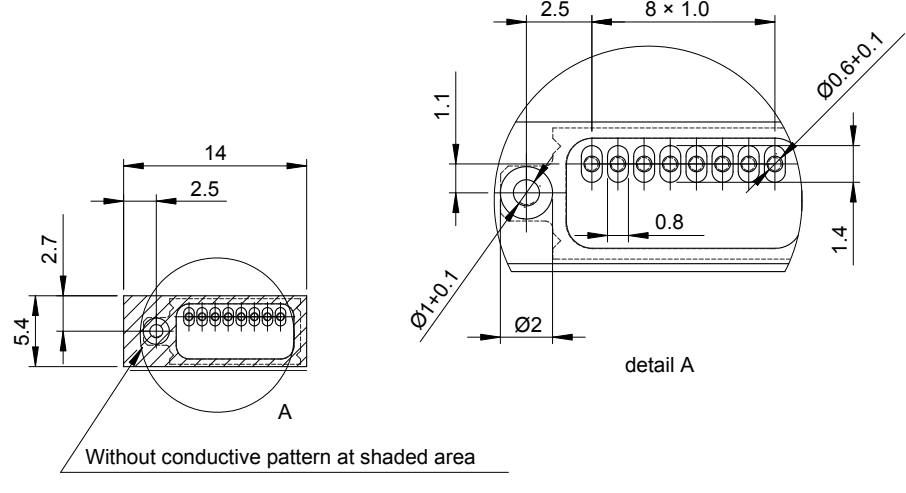

Note: Hand soldering temperature:
 T_{\max} 260 °C; t_{\max} 5 s
 Flow soldering not allowed.

Data sheet
RLMD01_08

RoLin readhead with flex cable

Dimensions and tolerances are in mm.

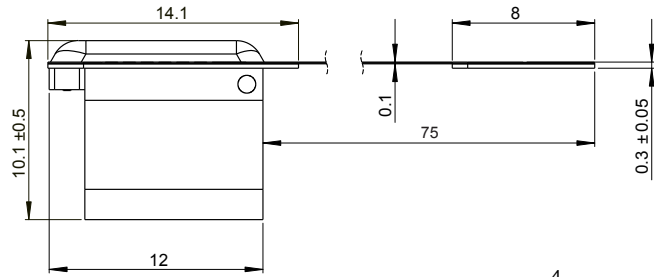
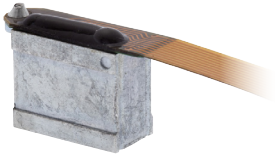

Connections

Pad	Signal	Function
1	-	Case
2	SLO	Output
3	MA	Input
4	Error	Output
5	V _{dd} (+5 V)	Power
6	GND (0 V)	Power
7	A	Output
8	Z	Output
9	B	Output
10	-	Case

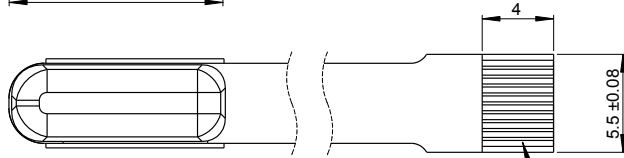

Dynamic bend radius: 5 mm
 Static bend radius: 1 mm

- Mating connectors*:
 Molex - 51281-1094
 Molex - 52745-1097
 Molex - 52746-1071
 JST - 10FLH-SM1-TB
 JST - 10FLH-RSM1-TB

* Not provided.

RoLin readhead with RS422 flex cable

Dimensions and tolerances are in mm.

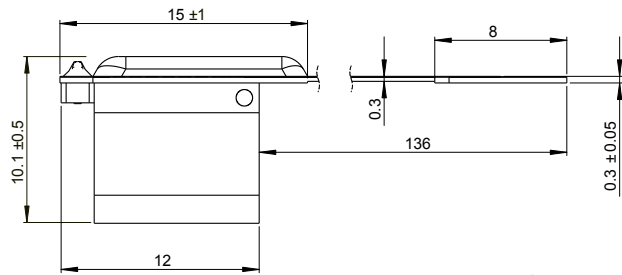
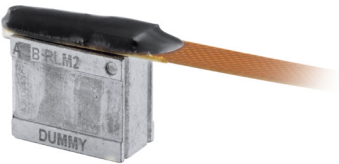

Connections

Pad	Signal	Function
1	-	Case
2	A	Output
3	A-	Output
4	B-	Output
5	V _{dd} (+5 V)	Power
6	GND (0 V)	Power
7	B	Output
8	Z-	Output
9	Z	Output
10	-	Case

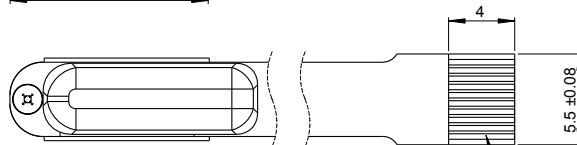

Dynamic bend radius: 20 mm
 Static bend radius: 5 mm

Note: Error signal not output

Position of installation holes

Recommended use of M2 screws with washers.

Mounting bracket dimensions

Dimensions and tolerances are in mm.

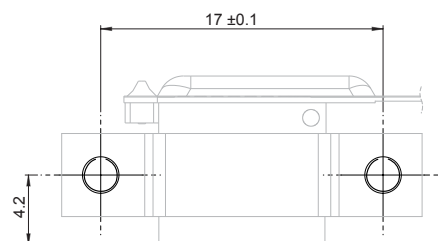
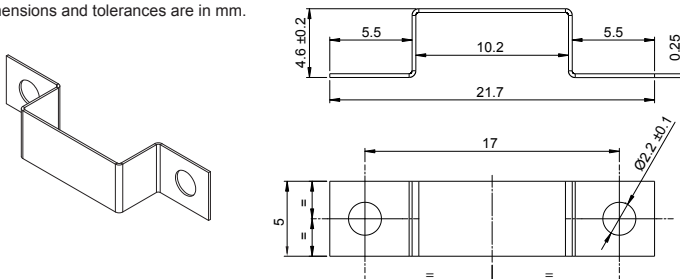

Installation tolerances

Dimensions and tolerances are in mm.

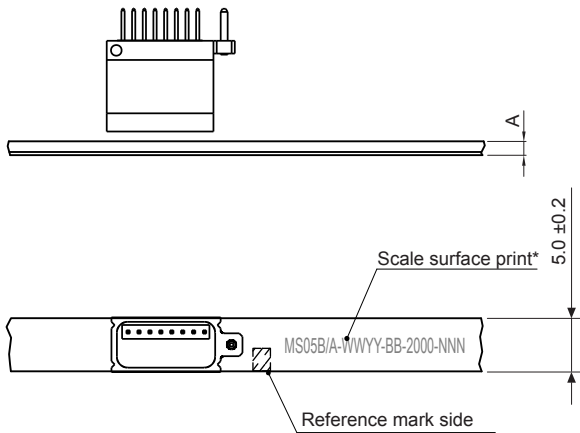

	Magnetic scale thickness (A)	Ride height (H)
With back-adhesion tape (option A)	1.5 ± 0.15	0.1–0.8
With back-adhesion tape, with cover foil (option B)	1.6 ± 0.15	0.1–0.7
No back-adhesion tape (option I)	1.3 ± 0.15	0.1–0.8
No back-adhesion tape, with cover foil (option N)	1.4 ± 0.15	0.1–0.7

* Scale surface print does not represent the actual part numbering. It is used for orientation purpose of the scale vs. readhead and contains information which allows the traceability of the scale to production data.

Ride height

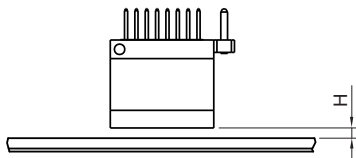

Lateral offset

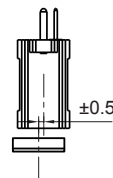

Pitch

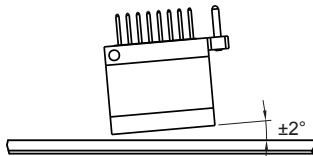

Roll

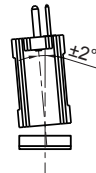

Yaw



For radial and axial ring installation tolerances refer to [magnetic ring data sheet](#).

Technical specifications

System data											
Maximum length for MS scale	50 m										
Pole length	2 mm										
For rotary maximum speed table refer to magnetic ring data sheet . Available resolutions and maximum speed for linear application:											
Part numbering	Resolution (µm)	Counts / 2 mm	Maximum speed (m/s)								
13B	≈ 0.244	8,192	1.82	0.91	0.23	0.11	0.06	0.03	0.02	0.01	0.01
12B	≈ 0.488	4,096	3.65	1.82	0.46	0.23	0.12	0.06	0.05	0.02	0.01
11B	≈ 0.976	2,048	7.30	3.65	0.91	0.46	0.24	0.12	0.10	0.05	0.02
2D0	1	2,000	7.47	3.73	0.93	0.47	0.24	0.12	0.10	0.05	0.02
1D6	1.25	1,600	9.33	4.67	1.17	0.58	0.30	0.16	0.12	0.06	0.03
10B	≈ 1.953	1,024	14.58	7.30	1.82	0.91	0.48	0.24	0.19	0.10	0.05
1D0	2	1,000	14.93	7.47	1.87	0.93	0.49	0.25	0.20	0.10	0.05
D80	2.5	800	18.67	9.33	2.34	1.17	0.61	0.31	0.25	0.12	0.06
09B	≈ 3.906	512	29.17	14.58	3.65	1.82	0.95	0.49	0.38	0.19	0.10
D50	4	500	29.87	14.93	3.73	1.87	0.97	0.50	0.39	0.20	0.10
D40	5	400	37.33	18.67	4.67	2.34	1.22	0.62	0.49	0.25	0.12
D32	6.25	320	46.67	23.33	5.84	2.91	1.52	0.78	0.61	0.31	0.16
08B	≈ 7.812	256	58.34	29.17	7.30	3.65	1.90	0.97	0.77	0.39	0.19
D20	10	200	74.67	37.33	9.33	4.67	2.43	1.24	0.98	0.50	0.25
D16	12.5	160	46.67	23.33	5.84	2.91	1.52	0.78	0.61	0.31	0.16
07B	15.625	128	80.00	58.34	14.58	7.30	3.81	1.94	1.53	0.77	0.39
D10	20	100	74.67	37.33	9.33	4.67	2.43	1.24	0.98	0.50	0.25
D08	25	80	46.67	23.33	5.84	2.91	1.52	0.78	0.61	0.31	0.16
06B	31.25	64	80.00	80.00	29.17	14.58	7.62	3.89	3.07	1.55	0.78
D04	50	40	46.67	23.33	5.84	2.91	1.52	0.78	0.61	0.31	0.16
05B	62.5	32	80.00	80.00	58.34	29.17	15.22	7.78	6.14	3.10	1.56
04B	125	16	n/a	80.00	80.00	58.34	30.43	15.56	12.28	6.19	3.11
03B	250	8	n/a	n/a	80.00	80.00	60.86	31.11	24.56	12.39	6.23
Minimum edge separation (µs)			0.07	0.12	0.50	1	2	4	5	10	20
Maximum count frequency (MHz)			15	8	2	1	0.5	0.25	0.2	0.1	0.05
Part numbering			K	A	B	C	D	E	F	G	H
Accuracy grade for MS scales	±40 µm										
Linear expansion coefficient for MS scale	~ 17 × 10 ⁻⁶ /K										
Repeatability	Better than unit of resolution for movement in the same direction										
Hysteresis	< 3 µm up to 0.2 mm ride height										
Hand soldering (for pin variant only)	T _{max} 260 °C; t _{max} 5 s										
Mechanical data											
Readhead housing material	ZnAl4Cu1 - zamak 5										
Mass	RLM readhead 1.4 g (without flex), 1.6 g (with flex); magnetic scale MS05 30 g/m; for radial and axial rings refer to magnetic ring data sheet										
Environmental											
Temperature	Operating	With flex cable:	-20 °C to +85 °C								
		Without flex cable:	-40 °C to +125 °C								
	Storage	-40 °C to +125 °C									
Vibrations (55 Hz to 2000 Hz)	300 m/s ² (IEC 60068-2-6)										
Shocks (11 ms)	300 m/s ² (IEC 60068-2-27)										
RoHS	Compliant with EU Directive 2002/95/EC										

RLM2DE – BiSS-C + Incremental, no line driver

Power supply	4.75 V to 5.5 V – voltage on readhead Reverse polarity protection
Power consumption	< 25 mA
Output signals	A, B, Z, Error, SLO
Saturation voltage hi (I = -4 mA)	$V_{dd} - 0.4$ V
Saturation voltage lo (I = 4 mA)	0.4 V
Rise and fall time ($c_c = 50$ pF)	60 ns
Input signals	MA
Threshold voltage hi	2 V
Threshold voltage lo	0.8 V
Permissible MA clock frequency	8 MHz
Reference signal	1 or more square-wave pulse Z
Timeout (Tto)	1.5 μ s

Timing diagram – BiSS-C

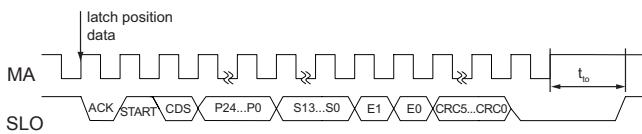

Data	Length	Description
P24 – P0	0 to 24 bit	Period counter value (length depends on the settings chosen)*
S12 – S0	3 to 13 bit	Position inside the period (length depends on the resolution)
E1 – E0	2 bit	Error data
CRC5 – CRC0	5 to 6 bit	Cyclic redundancy check data; polynomial 0×25 ; inverted bit output

* Optionally, period counter can be reset at the reference mark (options E, F and G - see page 9).

Error	E0	E1
No error	1	1
Amplitude error	0	1
Too high velocity	1	0
Undervoltage; Configuration; System error	0	0

For more information on BiSS-C protocol please visit www.biss-interface.com.

Timing diagram – Incremental, unique reference mark

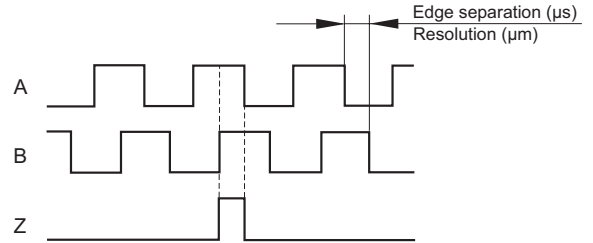

Timing diagram – Incremental, periodic reference mark

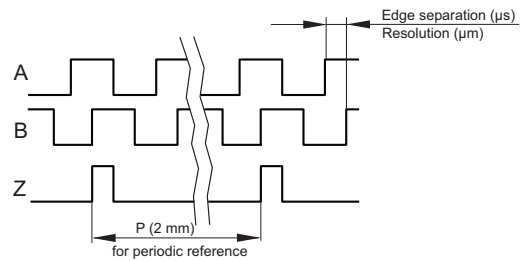

RLM2HD – Incremental, no line driver

Power supply	4.75 V to 5.5 V – voltage on readhead Reverse polarity protection
Power consumption	< 25 mA
Output signals	A, B, Z
Saturation voltage hi (I = -4 mA)	$V_{dd} - 0.4$ V
Saturation voltage lo (I = 4 mA)	0.4 V
Rise and fall time ($c_c = 50$ pF)	60 ns
Reference signal	1 or more square-wave pulse Z

Timing diagram – Incremental, unique reference mark

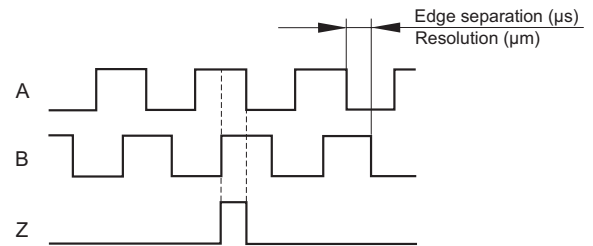

Timing diagram – Incremental, periodic reference mark

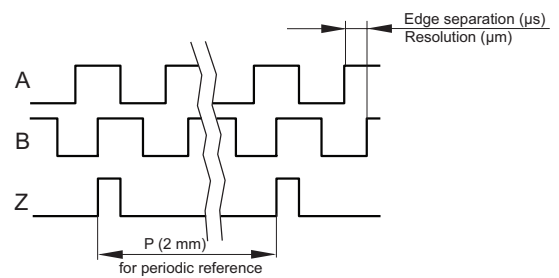

RLM2IC – Incremental, RS422

Power supply	4.75 V to 5.5 V – voltage on readhead Reverse polarity protection
Power consumption	< 30 mA
Output signals	A, B, Z, A-, B-, Z-
High level output voltage ($I_{OH} = -20$ mA)	> 2.4 V
Low level output voltage ($I_{OL} = 20$ mA)	< 0.4 V
Rise and fall time ($c_c = 50$ pF)	< 10 ns
Reference signal	1 or more square-wave pulse Z and its inverted pulse Z-

Timing diagram – Incremental, unique reference mark

Inverted signals are not shown

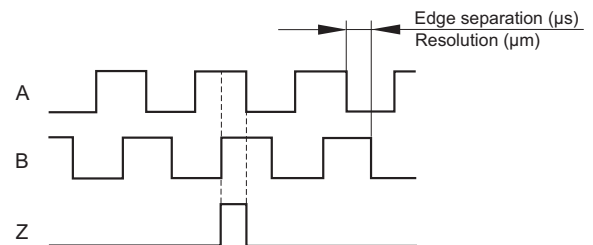

Timing diagram – Incremental, periodic reference mark

Inverted signals are not shown

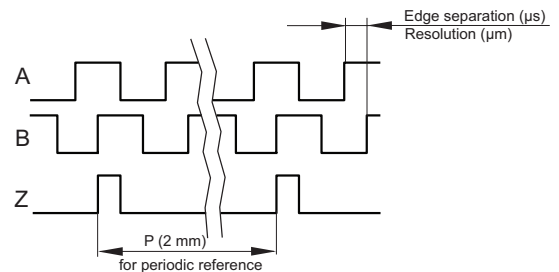

RLM2SJ – SSI + Incremental, no line driver

Power supply	4.75 V to 5.5 V – voltage on readhead Reverse polarity protection
Power consumption	< 25 mA
Output signals	A, B, Z, Error, SLO
Saturation voltage hi (I = –4 mA)	$V_{dd} - 0.4 V$
Saturation voltage lo (I = 4 mA)	0.4 V
Rise and fall time ($c_c = 50 pF$)	60 ns
Input signals	MA
Threshold voltage hi	2 V
Threshold voltage lo	0.8 V
Permissible MA clock frequency	4 MHz
Reference signal	1 or more square-wave pulse Z
Timeout (Tto)	20 μs

Timing diagram – SSI

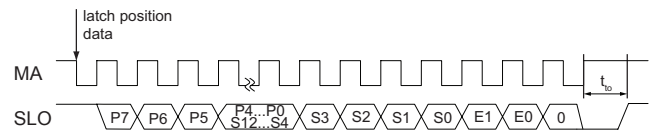

Error	E0	E1
No error	1	1
Amplitude error	0	1
Too high velocity	1	0
Undervoltage; Configuration; System error	0	0

Data	Description
P0 - P7	Period counter value (length depends on the settings chosen)*
S0 - S13	Position inside the period (length depends on the resolution)
E1 - E0	Error data

* Optionally, period counter can be reset at the reference mark (options E, F and G - see page 10).

Error output

To enable the successful diagnosis of faults, different types of errors are signalled on the Error line using a PWM formatted code as detailed below. In the case of amplitude or frequency failure the PWM cycle frequency is approximately 16.5 Hz (cycle duration: 60.7 ms).

Failure mode	Error output	Possible cause of failure
No error	High	Ride height too high
Amplitude error	Low: 75 % High: 25 %	Readhead removed from tape / ring Demagnetisation of magnetic tape / ring
Frequency error	Low: 50 % High: 50 %	Speed too high
Undervoltage	Low	Power supply low

If an error in amplitude occurs, the conversion process is terminated and the incremental output signals are halted. An error in amplitude rules out the possibility of an error in frequency.

Error output is open collector type with built in pull up resistor. It can be used in "wired-or" configuration with other error signals in the system.

Reference mark

Reference marks can be provided in 2 ways:

- 1) Selected at point of order.** The RoLin readhead should be ordered with reference mark option A. Magnetic scale or ring should be ordered with reference mark. If required, the cover foil can be installed over the reference mark.
- 2) Periodic reference mark, every 2 mm (as per scale pitch).** The RoLin readhead should be ordered with reference mark option C. Magnetic scale or ring should be ordered with **no** reference mark. Position information is output in incremental quadrature format with periodic reference signals. Reference periods correspond to pole length of magnetisation.

Distance coded reference marks. The readhead should be ordered with reference mark option A. The distance coded reference mark option provides multiple reference marks that are individually spaced according to specific mathematical algorithm. Absolute position is calculated after traversing 2 successive reference marks. Maximum length and minimal traverse depend on basic spacing (K) between reference marks, which is customer selectable at point of order. For further information please refer to [Distance coded reference mark data sheet \(LM10D17\)](#).

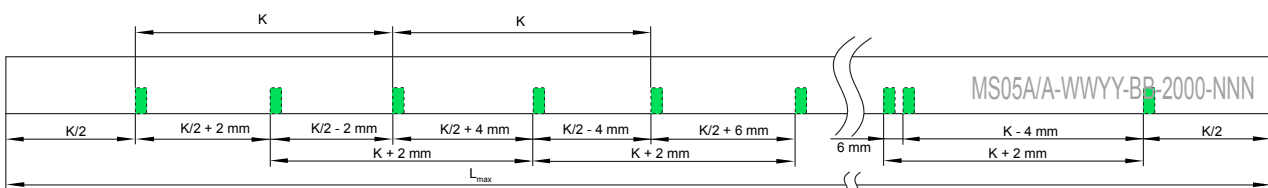

Multiple reference marks. For reference marks on multiple locations on the MS magnetic scale please contact RLS for a special part numbering.

Readhead part numbering



RoLin system

RLM readhead
eg. RLM2HDA13BA00A00

Magnetic scale / ring
eg. MS05BM100AM010 for scale /
MR047B040A076B00 for ring

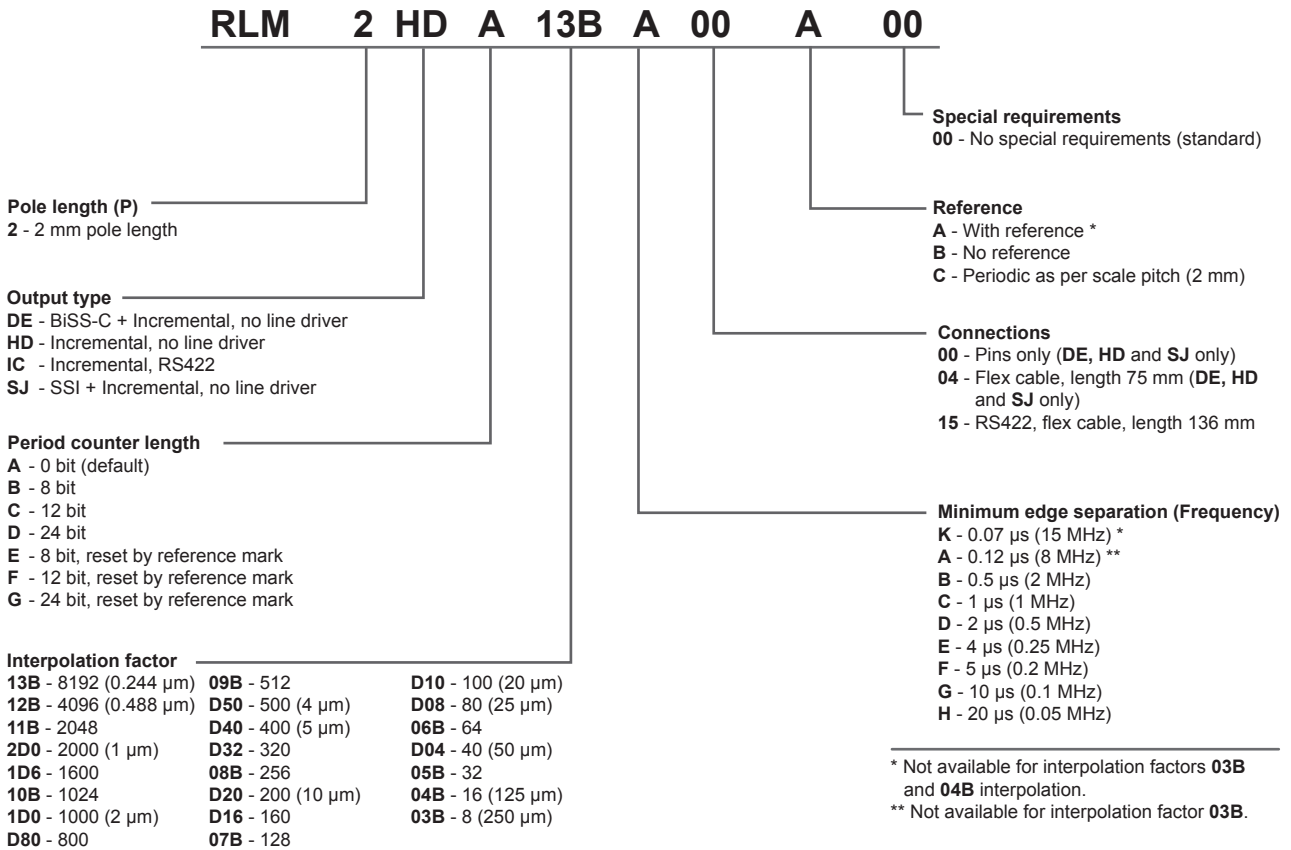

Formula for linear application resolution

$$\text{Resolution } (\mu\text{m}) = \frac{2000}{\text{Interpolation}}$$

Formula for rotary application resolution

$$\text{Resolution (ppr)} = \frac{\text{cpr}}{4}$$

$$\text{Resolution (cpr)} = \text{Pole number} \times \text{Interpolation}$$

For radial and axial ring part numbering refer to [magnetic ring data sheet](#).

Series	Output type	Period counter length	Interpolation factor	Minimum edge separation	FFC Connections	Reference	Special Requirements
RLM2	IC	A/B/C/D/E/F/G	xxx*	K/A/B/C/D/E/F/G/H	15	A/C	00
						B	
						C	
	04B		A/B/C/D/E/F/G/H	B			
				C			
				B			
			xxx*	K/A/B/C/D/E/F/G/H	00	A/C	
					04 / 15	B	
					00	C	
					04 / 15	B	
					00	C	
					04 / 15	B	
	HD/DE/SJ	A/B/C/D/E/F/G	04B	A/B/C/D/E/F/G/H	00	A/C	
					04 / 15	B	
					00	C	
					04 / 15	B	
					00	C	
					04 / 15	B	
			03B	B/C/D/E/F/G/H	00	A/C	
					04 / 15	B	
					00	C	
					04 / 15	B	

Magnetic scale part numbering

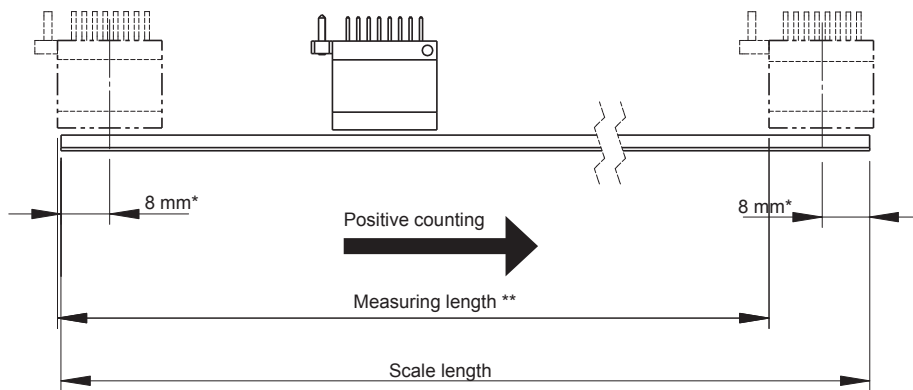

* Minimum distance of reference mark from left/right edge is 8 mm
 ** Beginning of measuring length from elastoferite layer edge is 0
 Measuring length = SL - 10 mm

MS05 B M100 A M010

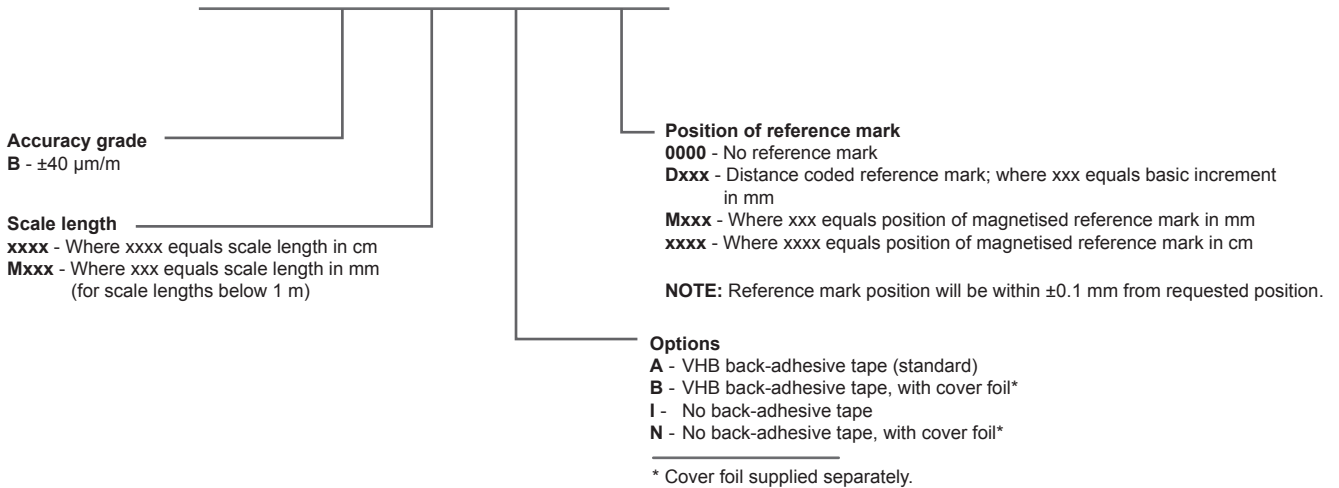

Cover foil part numbering

CF05 1000

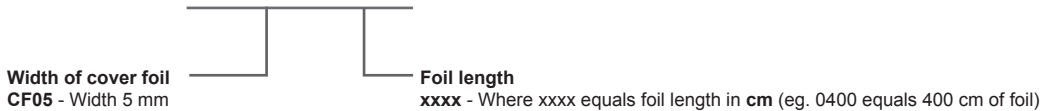

For radial and axial ring part numbering refer to [magnetic ring data sheet](#).

Accessories part numbering

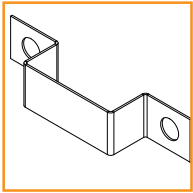

Mounting bracket
RLMMB01



USB encoder interface
E201



Connector adapters FFC
to DB9 (connect to E201):
RLACC001 for RLM2IC
RLACC002 for RLM2HD
RLACC003 for RLM2DE
and RLM2SJ
RLACC004 for RLM2IC



Magnet viewer
MM0001

Head office

RLS merilna tehnika d.o.o.

Poslovna cona Žeje pri Komendi
Pod vrbami 2
SI-1218 Komenda
Slovenia

T +386 1 5272100

F +386 1 5272129

E mail@rls.si

www.rls.si

Document issues

Issue	Date	Page	Corrections made
1	4. 2. 2011	-	New document
2	18. 2. 2011	2	Mounting bracket dimensions updated
		5	Timing diagram for unique reference added
		6	Magnetic ring part number updated
3	8. 4. 2011	2	PCB footprint added
		3	MS scale dimensions and measuring length start/end drawing added
		8	Magnetic scale installation drawing added
4	7. 10. 2011	2, 5, 7	Flex cable with integrated line driver added; 90 pole ring added
5	25. 11. 2014	2	Updated installation drawing dimension tolerance
		3	Magnetic scale thickness information updated
		4	Ring dimension tolerances updated; installation note added
		7	Edge separation and reference notes added
		8	Part numbering Options added
6	22. 12. 2014	1, 12	Period counter options added and explained
7	14. 1. 2015	7	76 pole ring resolutions corrected
8	18. 9. 2017	1	Ring reference and RoHS added
		2	Storage added
		6	Technical specifications amended
		7, 8	Output description added
		10, 11, 12, 13	Readhead, magnetic scale and accessories part numbering amended

RLS merilna tehnika d.o.o. has made considerable effort to ensure the content of this document is correct at the date of publication but makes no warranties or representations regarding the content. RLS merilna tehnika d.o.o. excludes liability, howsoever arising, for any inaccuracies in this document.
© 2017 RLS d.o.o.